

XML message for SEPA Direct Debit Initiation Implementation Guidelines for the Netherlands

Core and Business-to-Business Implementation Guidelines



Disclaimer

These guidelines may be subject to changes. Utmost care has been taken to ensure the information in this publication is accurate. However, the Dutch Payments Association (DPA) shall not be liable for any errors, inaccuracies or omissions in the contents of this publication.

Version 7.0 – February 2013

Contents

Introduction.....	3
Change History	4
Direct debit definition	6
Major differences Core and B2B	7
Coverage.....	8
Use of these Guidelines.....	9
Character set	10
Message Structure.....	11
Message items description.....	16
Annex A Detailed message item overview	61
Annex B Clieop03 equivalent.....	69
Annex C Rulebook attribute equivalent	70
Annex D Overview ISO codes	72
Annex E ISO Reason codes used	73
Annex F Generic ISO message Items	75
Annex G Example message.....	81
Annex H Overview of applicable usage rules	87

Introduction

This document describes the Implementation Guidelines for the XML SEPA Direct Debit Initiation message ISO20022 - “pain.008.001.02” in the Netherlands.

These Implementation Guidelines provide guidance on the use of the SEPA Direct Debit Initiation Message sent to Banks residing in The Netherlands. These guidelines are compliant with:

- ISO20022 – Message Definition Report edition September 2009
- EPC - SEPA Core Direct Debit Scheme Customer-to-Bank Implementation Guidelines, version 7.0, issued 30 November 2012 (EPC130-08)
- EPC - SEPA Business-to-business Direct Debit Scheme Customer-to-Bank Implementation Guidelines, version 5.0, issued 30 November 2012 (EPC131-08)

These guidelines can be used as of the date of release and replace all previous versions. No changes will be made anymore to any previous versions.

These Implementation Guidelines have been developed by the Dutch Payments Association (DPA). The utmost has been done to make sure the information in this publication is correct. However, the DPA can by no means be held responsible for any loss or damage incurred to any incorrect or incomplete information as described in this publication.

Please contact your bank for any further information.

Change History

New releases of the Implementation Guidelines are published on a regular basis, based on new versions of the underlying standards or to provide clarification where required. The following table provides an overview of the versions released to date.

Version	Date
2.0	October 2010
2.1	November 2010
2.2	February 2011
5.0	January 2012
5.0.1	February 2012
6.0	March 2012
7.0	February 2013

Versions are numbered x.y(.z). As from this version it has been decided to align the version numbering with that of the implementation guidelines as published by the EPC regarding the SCT. In case a new version of this document is released (mainly as a result of clarifications or error corrections) before the EPC releases a new version of the implementation guidelines, an additional minor release indicator z will be added (e.g. 5.0.1 for an updated version of this document).

The following additions and modifications have been made in version 7.0 compared to version 6.0:

Index	Description	Type
2.21	Either BIC or 'Other/Identification' must be used. When 'Other/Identification' is used, only 'NOTPROVIDED' is allowed in 'Identification'. The BIC is mandatory for EU/EEA cross border transactions until 31 January 2016.	CHAN ¹
2.21	Advise EPC usage rules effective per 1 January 2013 for NL domestic payments.	CHAN
2.27	For an overview of the Creditor Scheme Identification NL structure see: http://www.europeanpaymentscouncil.eu/knowledge_bank_download.cfm?file=EPC262-08_Creditor_Identifier_Overview_v2.3.pdf ATTENTION: Creditor Business Code (ZZZ) may not contain spaces.	CLAR ²
2.70	Either BIC or 'Other/Identification' must be used. When 'Other/Identification' is used, only 'NOTPROVIDED' is allowed in 'Identification'. The BIC is mandatory for EU/EEA cross border transactions until 31 January 2016.	CHAN

¹ CHAN: Change in further alignment with the Rulebook content or alignment with Dutch regulation/Dutch interbank agreements

² CLAR: Clarification of the text

2.70	Advise EPC usage rules effective per 1 January 2013 for NL domestic payments.	CHAN
2.72	In case of a mandate generated using data from a payment card at the point of sale which results in a direct debit to and from a payment account, and where the name of the Debtor is not available, the attribute "Name of the Debtor" must be filled in with "/CDGM" (note: Card Data Generated Mandate), followed by "/card number", "/sequence number" and "/expiry date of the card" (note: this means that the information parts are delimited by "/") or, if these data elements are not available, by any other data element(s) that would uniquely identify the Debtor to the Debtor Bank. This is only applicable in case Local Instrument is 'COR' or 'COR1'.	CHAN
2.90	Use End 2 End Identification if free text containing a specification of the payment used.	CHAN

Direct debit definition

A European Direct Debit is a payment instrument for making collections in Euro throughout SEPA from bank accounts designated to accept collections. The current definition of SEPA encompasses the EU member states together with Iceland, Liechtenstein, Monaco, Norway, and Switzerland.

Transactions for the collection of funds from a Debtor's account with a Debtor Bank are initiated by a Creditor via its bank (the Creditor agent) as agreed between Debtor and Creditor. This is based on an authorization given to the Creditor by the Debtor for the debit of its bank account: this authorization is referred to as the 'Mandate'. The Debtor and Creditor must each hold an account with a bank participating to the SEPA direct debit scheme.

Both Core and Business-to-Business European direct debits are described in this document.

The SEPA Core Direct Debit Scheme is intended for (but not limited to) payments where Debtors are consumer entities. The SEPA Business-to-Business Direct Debit Scheme is intended for business payments where Debtors are business rather than consumer entities.

Both recurrent and one-off collections can be processed. Recurrent direct debits are those where the authorization by the Debtor is used for regular direct debits initiated by the Creditor. One-off direct debits are those where the authorization is given to initiate only one single direct debit, authorization which cannot be used for any subsequent transaction. All transactions must be in Euro.

Major differences Core and B2B

Subject	Core scheme	B2B scheme
Access to the scheme	Both retail and corporate	Only corporate
Debtor		Recommended to submit signed B2B mandate to the debtor bank for upfront registration
Checks by Debtor bank	Is SDD transaction allowed for the account/account type	<p>Need authorisation from debtor</p> <p>Is obliged to keep track of authorisation of debtor for each mandate, including additional instructions (if offered through AOS).</p> <p>Obligated to check for every transaction received whether for MRI included an authorisation of the debtor is obtained.</p> <p>At least check on the following mandate details: Identification code of the scheme: B2B Unique mandate reference Creditor scheme Id IBAN debtor BIC debtor bank Transaction type (one-off, recurring) Check on additional details (if offered through AOS) Further more to check: Has authorisation been cancelled/withdrawn Has authorisation been changed Is mandate dormant (due to 36 month of inactivity)</p> <p>Obligation to check if client is a corporate should be applied at the moment of lodging authorisation from debtor client.</p>
Schemerule transaction timeline	D-5/D-2 Optional shorter time cycle 'D-1' (for details on this option please do refer to SDD Rulebook 6.0; Chapter 4.3.4)	D-1
Schemerule refusal timeline	pre-settlement	pre-settlement
Schemerule return timeline	D+5	D+2
Schemerule refund timeline	Bookdate + 8 weeks	Not allowed
Creditor mandate		<p>The debtor must be able to recognise the mandate is about B2B.</p> <p>Specific text on the mandate should explain this e.g. Only applicable to B2B transactions No right for refunds</p>

Coverage

The Customer Direct Debit Initiation message is sent by the initiating party to the creditor agent. It is used to request bulk collections of funds from one or various debtor's accounts for a creditor. The Customer Direct Debit Initiation message can contain one or more direct debit instructions. The message can be used in a direct scenario, which means that the message is sent directly to the creditor agent. The creditor agent is the account servicer of the creditor.

The message can also be used by an initiating party that has authority to send the message on behalf of the creditor. This caters for example for the scenario of a payments factory initiating all payments on behalf of a large corporate.

The Customer Direct Debit Initiation contains mandate related information, i.e. extracts from a mandate, such as Mandate Identification and Date Of Signature. The customer Direct Debit Initiation message must not be considered as a mandate.

Use of these Guidelines

Each item of the DirectDebitInitiation message refers to the corresponding index of the item in the ISO 20022 Message Definition Report for Payment Standards – Initiation. This Report can be found on www.iso20022.org, under “Catalogue of ISO 20022 messages”, with “pain.008.001.02” as reference. (www.iso20022.org/documents/general/Payments_Maintenance_2009.zip).

This document is based upon the UNIFI (ISO 20022) XML message standards and the EPC SEPA Direct Debit Core and B2B scheme customer-to-bank implementation guidelines. These implementation guidelines can be found on: [http://www.europeanpaymentscouncil.eu/content.cfm?page=sepa_direct_debit_\(sdd\)](http://www.europeanpaymentscouncil.eu/content.cfm?page=sepa_direct_debit_(sdd)). In addition the Dutch specific usage rules are added.

The description of each message item contains:

Index	Number that refers to the corresponding description in the UNIFI (ISO 20022) Message Definition Report for Payment Standards – Initiation
XML Tag	Short name that identifies an element within an XML message, that is put between brackets, e.g. <Amount>
Occurrences	<p>This indicates whether an element is optional or mandatory and how many times the element can be repeated. The number of occurrences is shown in square brackets</p> <p>For example:</p> <p>[0..1] shows that the element can be present 0 times or 1 time. The element is optional</p> <p>[1..1] shows that the element can only be present 1 time. The element is mandatory</p> <p>[1..n] shows that the element is mandatory and can be present 1 to n times</p> <p>An element, that is part of a block of elements, is mandatory as far as the block it is part of, is present in the message.</p> <p>If only one of several elements may be present, this is indicated by {OR ... OR} before the elements concerned.</p>
Format	This specifies the permitted values and format

Definition	This contains the definition of the message block or element
Usage ISO	Additional info how this element must be used according to the ISO standards
Usage EPC	Any specific rules that could impact the presence or the values of an element as set in the SEPA Direct Debit scheme customer-to-bank implementation guidelines
Usage NL	Any additional rules as set by the DPA specific for the Dutch community

Character set

The UTF-8 character encoding standard must be used in the ISO 20022 messages.

The Latin character set, commonly used in international communication, must be used.

It contains the following characters:

a b c d e f g h i j k l m n o p q r s t u v w x y z
 A B C D E F G H I J K L M N O P Q R S T U V W X Y Z
 0 1 2 3 4 5 6 7 8 9
 / - ? : () . , ' +
 Space

Note: the above is about characters that can be used within the tags. For the message itself also other characters (especially < and >) can be used.

Message Structure

The description of the ISO 20022 document models can be found in a number of schemes. A specific description language (XSD) is used in those schemes. The schemes make it possible to give a description of the tags in the document, the structure and sequence of those beacons (hierarchy of tags) as well as the codes which are allowed for some specific data, the number of possible cases, the obligatory or optional character of some of the data, etc.

The general XSD for pain.008.001.02 can be downloaded from:

www.iso20022.org, under “Catalogue of ISO 20022 messages”, with “pain.008.001.02” as reference
<http://www.iso20022.org/documents/messages/pain/schemas/pain.008.001.02.zip>

A file containing an XML- pain.008.001.02 message has the following structure³:

```
<?xml version="1.0" encoding="UTF-8"?>
<Document xmlns="urn:iso:std:iso:20022:tech:xsd:pain.008.001.02" xmlns:xsi="http://www.w3.org/2001/XMLSchema-
instance">
    <CstmrDrctDbtInitn>
        message content ...
    </CstmrDrctDbtInitn>
</Document>
```

A file must contain one single Document (envelope), with one single XML message in it. For an example message is referred to the Annex. The support of multiple documents per file must be agreed bilaterally with your bank.

The Customer Direct Debit Initiation message is composed of 3 building blocks:

- A. Group Header: This building block is mandatory and present once. It contains elements such as Message Identification, Creation Date And Time, Grouping indicator.

³ for an XML-pain.008.001.02 message example go to:

<http://www.betalvereniging.nl/wp-uploads/2013/01/BvN-pain.008.001.02-example-message.xml>

- B. Payment Information: This building block is mandatory and repetitive. It contains, amongst others, elements related to the Credit side of the transaction, such as Creditor and Payment Type Information.
- C. Direct Debit Transaction Information: This building block is mandatory and repetitive. It contains, amongst others, elements related to the debit side of the transaction, such as Debtor and Remittance Information Rules.

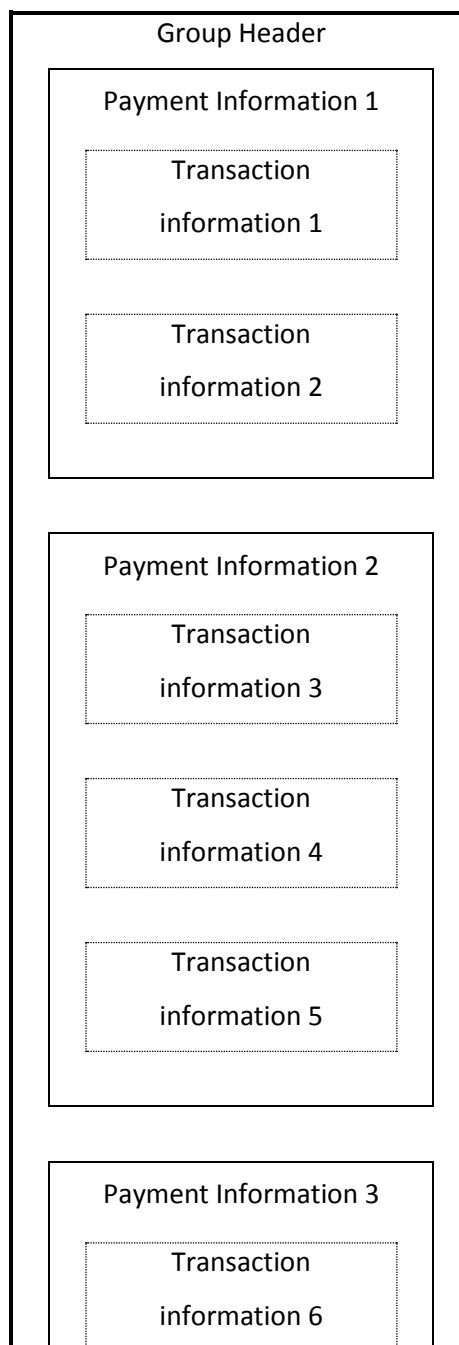

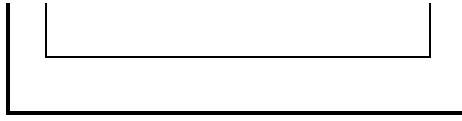

A detailed view on the structure of a Direct Debit Initiation Message is presented below.

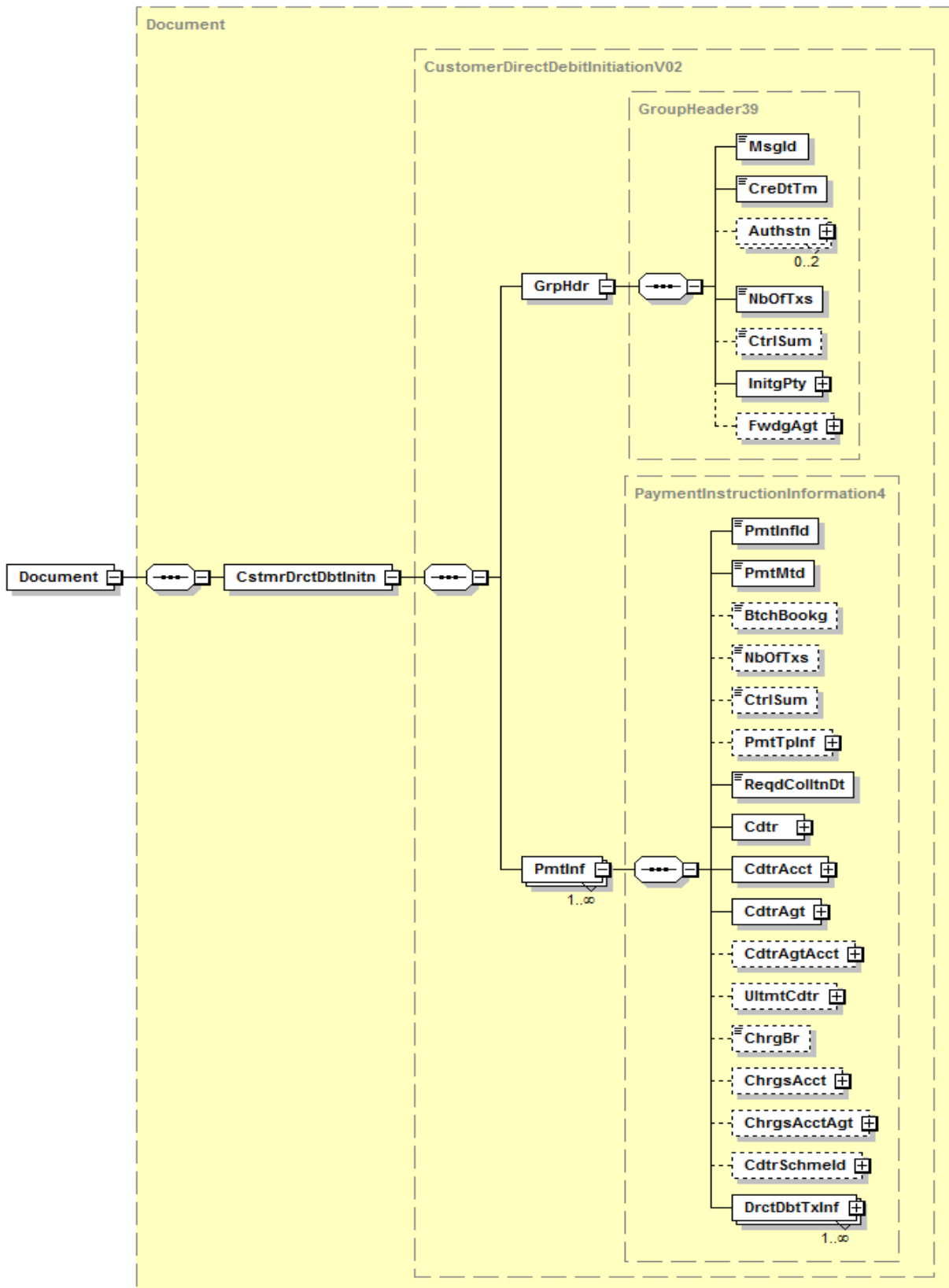

Legend:

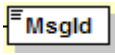

Box with full-line is a **mandatory** Message Element

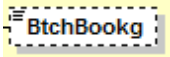

Box with dotted line is an **optional** Message Element

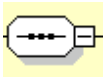

The Child Elements must appear in the **sequence** mentioned



Only one of the possible Child Elements may be present (choice)

Message items description

0.0 CustomerDirectDebitInitiation

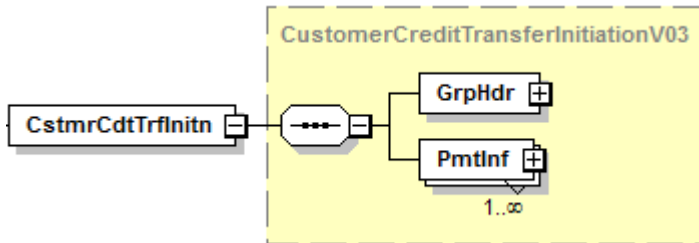

XML Tag: <CstmrDrctDbtInittn>

Occurrence: [1..1]

Definition: Root element

Type: The CustomerDirectDebitInitiation block is composed of the following CustomerDirectDebitInitiationV02 element(s):

Index	Or	MessageItem	<XMLTag>	Mult.	Represent./Type
1.0		GroupHeader	<GrpHdr>	[1..1]	+
2.0		PaymentInformation	<PmtInf >	[1..n]	+

1.0 GroupHeader

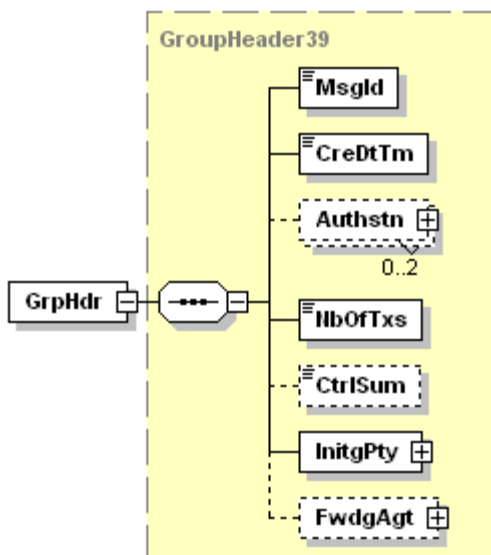

XML Tag: <GrpHdr>

Occurence: [1..1]

Definition: Set of characteristics shared by all individual transactions included in the message.

Type: The GroupHeader block is composed of the following GroupHeader39 element(s):

Index	Or	Message Item	<XML Tag>	Mult.	Represent./Type
1.1		MessageIdentification	<MsgId>	[1..1]	Text
1.2		CreationDateTime	<CreDtTm>	[1..1]	Date
1.3		Authorisation	<Authstn>	[0..2]	
1.6		NumberOfTransactions	<NbOfTxs>	[1..1]	Text
1.7		ControlSum	<CtrlSum>	[0..1]	Quantity
1.8		InitiatingParty	<InitgPty>	[1..1]	+
1.9		ForwardingAgent	<FwdgAgt>	[0..1]	+

1.1 MessageIdentification



XML Tag: <MsgId>

Occurrence: [1..1]

Definition: Point to point reference, assigned by the instructing party and sent to the next party in the chain, to unambiguously identify the message.

Usage ISO: The instructing party has to make sure that MessageIdentification is unique per instructed party for a pre-agreed period.

Data Type: Max35Text

Format: maxLength: 35
minLength: 1

1.2 CreationDateTime

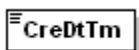

XML Tag: <CreDtTm>

Occurrence: [1..1]

Definition: Date and time at which a (group of) payment instruction(s) was created by the instructing party.

Data Type: ISODatetime

1.3 Authorisation

Message Element that is not part of the addendum for the IG SDD Netherlands but is available for future use in a SEPA AOS.

1.4 Code

Message Element that is not to be used in SEPA Payments for NL.

1.5 Proprietary

Message Element that is not to be used in SEPA Payments for NL.

1.6 NumberOfTransactions

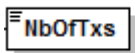

XML Tag:	<NbOfTxS>
Occurence:	[1..1]
Definition:	Number of individual transactions contained in the message.
Data Type:	Max15NumericText
Format:	[0-9]{1,15}

1.7 ControlSum

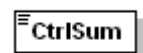

XML Tag:	<CtrlSum>
Occurence:	[0..1]
Definition:	Total of all individual amounts included in the message.
Data Type:	DecimalNumber
Format:	fractionDigits: 17
totalDigits:	18
Usage NL:	Total of all individual amounts included in the message.

1.8 InitiatingParty

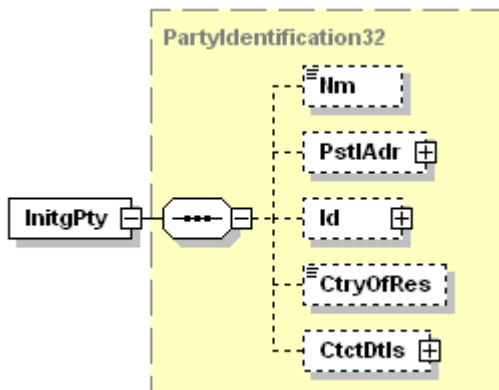

XML Tag: <InitgPty>

Occurrence: [1..1]

Definition: Party that initiates the payment.

Usage ISO: This can either be the creditor or a party that initiates the direct debit on behalf of the creditor.

Type: This Message Item is composed of the following PartyIdentification32 element(s):

Or	Message Item	<XML Tag>	Mult.	Represent./Type
	Name	<Nm>	[0..1]	Text
	PostalAddress	<PstlAdr>	[0..1]	
	Identification	<Id>	[0..1]	
	CountryOfResidence	<CtryOfRes>	[0..1]	Code
	ContactDetails	<CtctDtls>	[0..1]	

Usage EPC: 'Name' is limited to 70 characters in length.

'OrganisationIdentification': Either 'BIC or BEI' or one occurrence of 'Other' is allowed.

'PrivateIdentification': Either 'Date and Place of Birth' or one occurrence of 'Other' is allowed.

1.9 ForwardingAgent

Message Element that is not part of the addendum for the IG SDD Netherlands but is available for future use in a SEPA AOS.

2.0 PaymentInformation

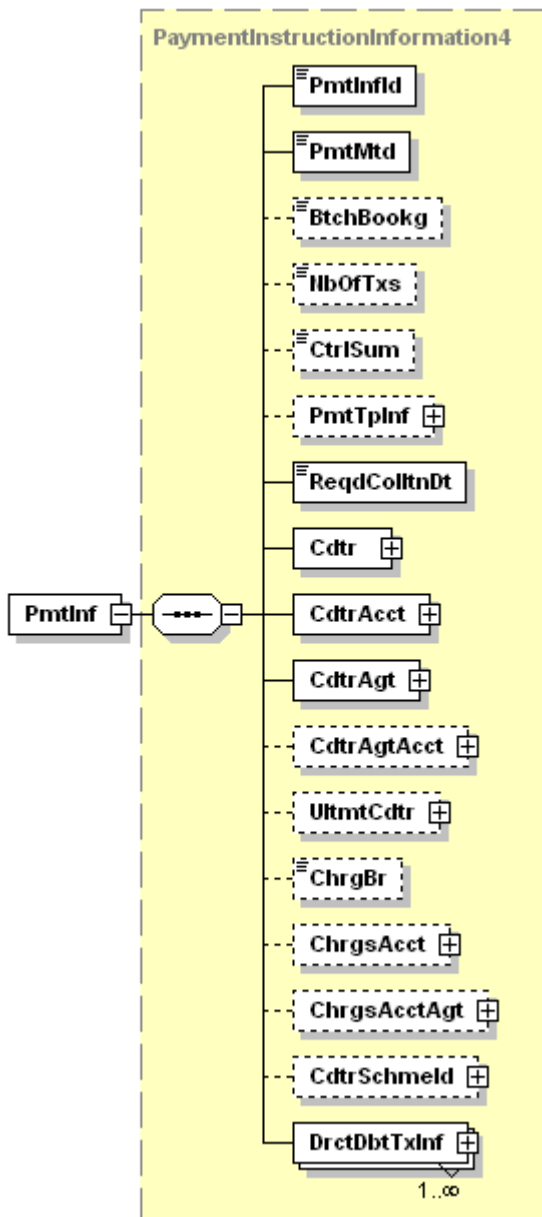

XML Tag: <PmtInf>

Occurence: [1..n]

Definition: Set of characteristics that apply to the credit side of the payment transactions included in the direct debit transaction initiation.

Type: The PaymentInformation block is composed of the following PaymentInstructionInformation4 element(s):

Index	Or	Message Item	<XML Tag>	Mult.	Represent./Type
2.1		PaymentInformationIdentification	<PmtInfId>	[1..1]	Text

2.2		PaymentMethod	<PmtMtd>	[1..1]	Code
2.3		BatchBooking	<BtchBookg>	[0..1]	Indicator
2.4		NumberOfTransactions	<NbOfTxS>	[0..1]	Text
2.5		ControlSum	<CtrlSum>	[0..1]	Quantity
2.6		PaymentTypeInfoInformation	<PmtTPlnf>	[0..1]	
2.18		RequestedCollectionDate	<ReqdColltnDt>	[1..1]	DateTime
2.19		Creditor	<Cdtr>	[1..1]	+
2.20		CreditorAccount	<CdtrAcct>	[1..1]	+
2.21		CreditorAgent	<CdtrAgt>	[1..1]	+
2.22		CreditorAgentAccount	<CdtrAgtAcct>	[0..1]	+
2.23		UltimateCreditor	<UltmtCdtr>	[0..1]	+
2.24		ChargeBearer	<ChrgBr>	[0..1]	Code
2.25		ChargesAccount	<ChrgsAcct>	[0..1]	+
2.26		ChargesAccountAgent	<ChrgsAcctAgt>	[0..1]	+
2.27		CreditorSchemeldentification	<CdtrSchmeld>	[0..1]	+
2.28		DirectDebitTransactionInformation	<DrctDbtTxInf>	[1..n]	

2.1 PaymentInformationIdentification

PmtInfd

XML Tag: <PmtInfd>

Occurence: [1..1]

Definition: Unique identification, as assigned by a sending party, to unambiguously identify the payment information group within the message.

Data Type: Max35Text

Format: maxLength: 35

minLength: 1

2.2 PaymentMethod

PmtMtd

XML Tag: <PmtMtd>

Occurence: [1..1]

Definition: Specifies the means of payment that will be used to move the amount of money.

Data Type: Code

One of the following PaymentMethod2Code values must be used:

Code	Name	Definition
DD	DirectDebit	Collection of an amount of money from the debtor's bank account by the creditor. The amount of money and dates of collections may vary.

2.3 BatchBooking

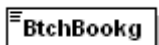

XML Tag: <BtchBookg>

Occurence: [0..1]

Definition: Identifies whether a single entry per individual transaction or a batch entry for the sum of the amounts of all transactions within the group of a message is requested.

Usage ISO: Batch booking is used to request and not order a possible batch booking.

Data Type: One of the following BatchBookingIndicator values must be used:

MeaningWhenTrue: Identifies that a batch entry for the sum of the amounts of all transactions in the message is requested.

MeaningWhenFalse: Identifies that a single entry for each of the transactions in the message is requested.

Usage EPC: If present and contains 'true', batch booking is requested.

If present and contains 'false', booking per transaction is requested.

If element is not present, pre-agreed customer-to-bank conditions apply

2.4 NumberOfTransactions

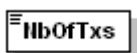

XML Tag: <NbOfTxS>

Occurence: [0..1]

Definition: Number of individual transactions contained in the payment information group.

Data Type: Max15NumericText

Format: [0-9]{1,15}

2.5 ControlSum



XML Tag: <CtrlSum>
 Occurence: [0..1]
 Definition: Total of all individual amounts included in the group.
 Data Type: DecimalNumber
 Format: fractionDigits: 17 totalDigits: 18
 Usage NL: Total of all individual amounts included in the group (under index 2.0).

2.6 PaymentTypeInformation

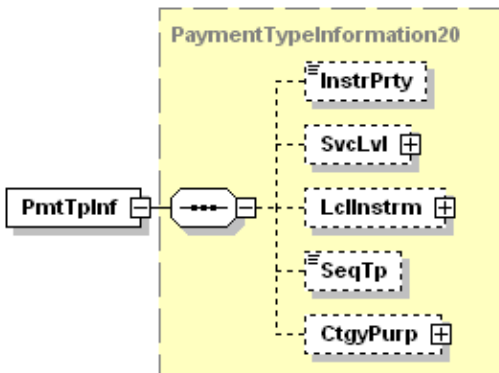

XML Tag: <PmtTpInf>
 Occurence: [1..1]
 Definition: Set of elements used to further specify the type of transaction.
 Type: This Message Item is composed of the following PaymentTypeInformation20 element(s):

Index	Or	Message Item	<XML Tag>	Mult.	Represent./Type
2.7		InstructionPriority	<InstrPrty>	[0..1]	Code
2.8		ServiceLevel	<SvcLvl>	[0..1]	
2.11		LocalInstrument	<LclInstrm>	[0..1]	
2.14		SequenceType	<SeqTp>	[0..1]	Code
2.15		CategoryPurpose	<CtgypPurp>	[0..1]	

Usage ISO: PaymentTypeInformationRule. If PaymentTypeInformation is present, then DirectDebitTransactionInformation/PaymentTypeInformation is not allowed.

Usage EPC: Mandatory

2.7 InstructionPriority

Message Element that is not part of the addendum for the IG SDD Netherlands but is available for FUTURE use in a SEPA AOS.

2.8 ServiceLevel

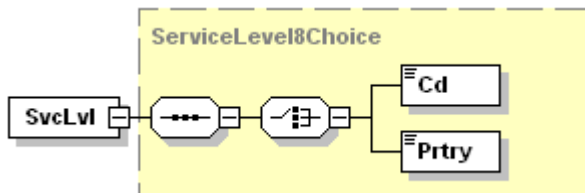

XML Tag: <SvcLvl>

Occurence: [1..1]

Definition: Agreement under which or rules under which the transaction should be processed.

Type: This Message Item is composed of one of the following ServiceLevel8Choice element(s):

Index	Or	Message Item	<XML Tag>	Mult.	Represent./Type
2.9	{Or	Code	<Cd>	[1..1]	Code
2.10	Or}	Proprietary	<Prtry>	[1..1]	Text

Usage EPC: Mandatory

2.9 Code

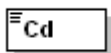

XML Tag: <Cd>

Occurence: [1..1]

Definition: Specifies a pre-agreed service or level of service between the parties, as published in an external service level code list.

Data Type: ExternalServiceLevel1Code

Format: maxLength: 4

minLength: 1

Usage EPC: Only 'SEPA' is allowed.

This Message Item is part of choice 2.8 ServiceLevel.

2.10 Proprietary

Message Element that is not part of the addendum for the IG SDD Netherlands but is available for FUTURE use in a SEPA AOS.

2.11 LocalInstrument

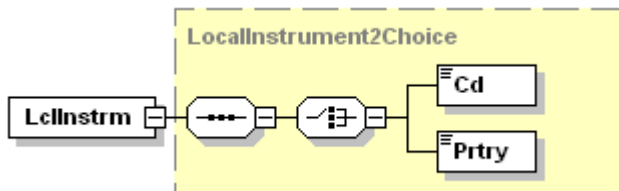

XML Tag: <LclInstrm>

Occurence: [1..1]

Definition: User community specific instrument.

Usage ISO: This element is used to specify a local instrument, local clearing option and/or further qualify the service or service level.

Type: This Message Item is composed of one of the following LocalInstrument2Choice element(s):

Index	Or	Message Item	<XML Tag>	Mult.	Represent./Type
2.12	{Or	Code	<Cd>	[1..1]	Code
2.13	Or}	Proprietary	<Prtry>	[1..1]	Text

Usage EPC: Mandatory

2.12 Code

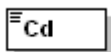

XML Tag: <Cd>

Occurence: [1..1]

This Message Item is part of choice 2.11 LocalInstrument.

Definition: Specifies the local instrument, as published in an external local instrument code list.

Data Type: ExternalLocalInstrument1Code

Format: maxLength: 35

minLength: 1

Usage EPC: Only 'CORE', 'COR1' or 'B2B' are allowed.

- 'CORE' is used to indicate a Core direct debit.

- 'COR1' is used to cater for optional shorter time cycle (D-1) for a Core direct debit
- 'B2B' is used to indicate a B2B direct debit.

The mixing of different local instrument values is not allowed in the same message.

2.13 Proprietary

Message Element that is not part of the addendum for the IG SDD Netherlands but is available for future use in a SEPA AOS.

2.14 SequenceType

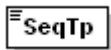

XML Tag: <SeqTp>

Occurrence: [1..1]

Definition: Identifies the direct debit sequence, such as first, recurrent, final or one-off.

Data Type: Code

When this Message Item is present, one of the following SequenceType1Code values must be used:

Code	Name	Definition
FNAL	Final	Final collection of a series of direct debit instructions.
FRST	First	First collection of a series of direct debit instructions.
OOFF	OneOff	Direct debit instruction where the debtor's authorisation is used to initiate one single direct debit transaction.
RCUR	Recurring	Direct debit instruction where the debtor's authorisation is used for regular direct debit transactions initiated by the creditor.

Usage EPC: Mandatory

If 'Amendment Indicator' is 'true', and 'Original Debtor Agent' is set to 'SMNDA', this message element must indicate 'FRST'.

Usage NL: Allowed codes: FRST, RCUR, OOFF, FNAL

2.15 CategoryPurpose

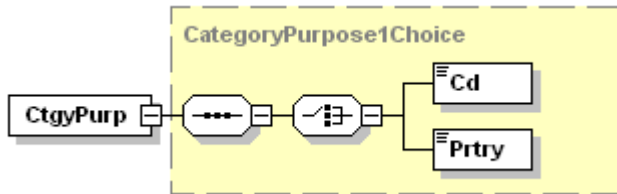

XML Tag: <CtgyPurp>

Occurence: [0..1]

Definition: Specifies the high level purpose of the instruction based on a set of pre-defined categories.

Usage ISO: This is used by the initiating party to provide information concerning the processing of the payment. It is likely to trigger special processing by any of the agents involved in the payment chain.

Type: This Message Item is composed of one of the following CategoryPurpose1Choice element(s):

Index	Or	Message Item	<XML Tag>	Mult.	Represent./Type
2.16	{Or	Code	<Cd>	[1..1]	Code
2.17	Or}	Proprietary	<Prtry>	[1..1]	Text

Usage EPC: Depending on the agreement between the Creditor and the Creditor Bank, 'Category Purpose' may be forwarded to the Debtor Bank.

2.16 Code

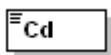

XML Tag: <Cd>

Occurence: [1..1]

This Message Item is part of choice 2.15 CategoryPurpose.

Definition: Category purpose, as published in an external category purpose code list.

Data Type: ExternalCategoryPurpose1Code

Format: maxLength: 4

minLength: 1

2.17 Proprietary

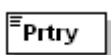

XML Tag: <Prtry>

Occurence: [1..1]

This Message Item is part of choice 2.15 CategoryPurpose.

Definition: Category purpose, in a proprietary form.

Data Type: Max35Text

Format: maxLength: 35

minLength: 1

2.18 RequestedCollectionDate

ReqdColltnDt

XML Tag: <ReqdColltnDt>

Occurence: [1..1]

Definition: Date and time at which the creditor requests that the amount of money is to be collected from the debtor.

Data Type: ISODate

2.19 Creditor

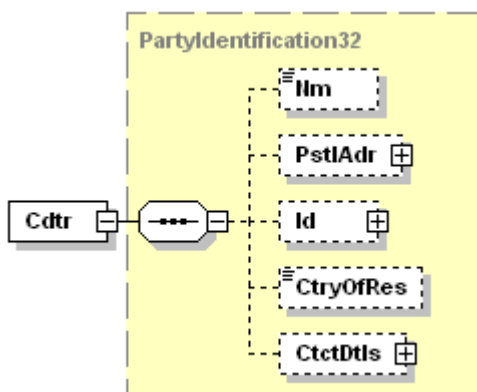

XML Tag: <Cdtr>

Occurence: [1..1]

Definition: Party to which an amount of money is due.

Type: This Message Item is composed of the following PartyIdentification32 element(s):

Or	Message Item	<XML Tag>	Mult.	Represent./Type
	Name	<Nm>	[0..1]	Text
	PostalAddress	<PstlAdr>	[0..1]	
	Identification	<Id>	[0..1]	

	CountryOfResidence	<CtryOfRes>	[0..1]	Code
	ContactDetails	<CtctDtls>	[0..1]	

Usage EPC: 'Name' is mandatory
 'Name' is limited to 70 characters in length.
 Only two occurrences of AddressLine are allowed.

2.20 CreditorAccount

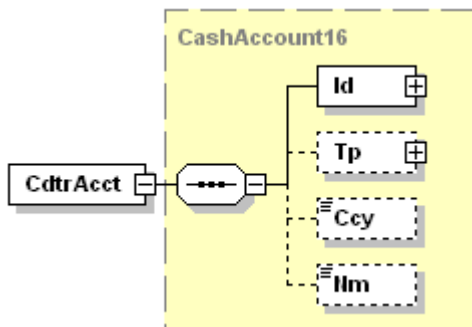

XML Tag: <CdtrAcct>

Occurence: [1..1]

Definition: Unambiguous identification of the account of the creditor to which a credit entry will be posted as a result of the payment transaction.

Type: This Message Item is composed of the following CashAccount16 element(s):

Or	Message Item	<XML Tag>	Mult.	Represent./Type
	Identification	<Id>	[1..1]	
	Type	<Tp>	[0..1]	
	Currency	<Ccy>	[0..1]	Code
	Name	<Nm>	[0..1]	Text

Usage EPC: 'Identification': Only IBAN is allowed.

2.21 CreditorAgent

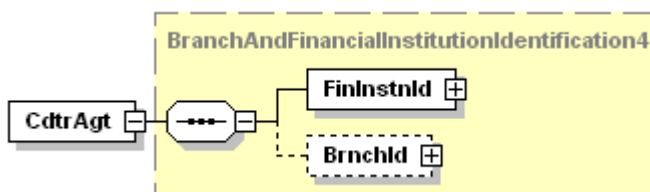

XML Tag: <CdtrAgt>

Occurence: [1..1]

Definition: Financial institution servicing an account for the creditor.

Type: This Message Item is composed of the following
BranchAndFinancialInstitutionIdentification4 element(s):

Or	Message Item	<XML Tag>	Mult.	Represent./Type
	FinancialInstitutionIdentification	<FinInstnId>	[1..1]	
	BranchIdentification	<BrnchId>	[0..1]	

Usage EPC: Either BIC or 'Other/Identification' must be used. When 'Other/Identification' is used, only 'NOTPROVIDED' is allowed in 'Identification'. The BIC is mandatory for EU/EEA cross border transactions until 31 January 2016.

Usage NL: Advise EPC usage rules effective per 1 January 2013 for NL domestic payments.

2.22 CreditorAgentAccount

Message Element that is not part of the addendum for the IG SDD Netherlands but is available for future use in a SEPA AOS.

2.23 UltimateCreditor

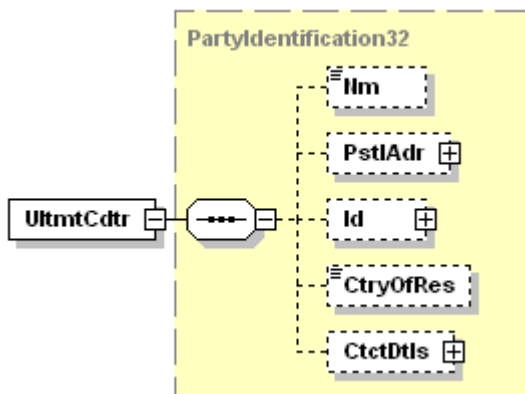

XML Tag: <UltmtCdtr>

Occurrence: [0..1]

Definition: Ultimate party to which an amount of money is due.

Type: This Message Item is composed of the following PartyIdentification32 element(s):

Or	Message Item	<XML Tag>	Mult.	Represent./Type
	Name	<Nm>	[0..1]	Text
	PostalAddress	<PstlAdr>	[0..1]	
	Identification	<Id>	[0..1]	
	CountryOfResidence	<CtryOfRes>	[0..1]	Code

	ContactDetails	<CtctDtls>	[0..1]	
--	----------------	------------	--------	--

- Usage ISO: UltimateCreditorRule
 If UltimateCreditor is present, then DirectDebitTransactionInformation/UltimateCreditor is not allowed.
 If DirectDebitTransactionInformation/UltimateCreditor is present, then UltimateCreditor is not allowed.
 DirectDebitTransactionInformation/UltimateCreditor and UltimateCreditor may both be absent.
- Usage EPC: The 'UltimateCreditor' data element may be present either at 'Payment Information' or at 'Direct Debit Transaction Information' level.
 'Name' is limited to 70 characters in length.
 'OrganisationIdentification': Either 'BIC or BEI' or one occurrence of 'Other' is allowed.
 'Privateldentification': Either 'Date and Place of Birth' or one occurrence of 'Other' is allowed.
- Guideline(s): UltimateCreditorGuideline
 UltimateCreditor may only be present if different from Creditor.

2.24 ChargeBearer

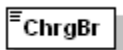

- XML Tag: <ChrgBr>
- Occurence: [0..1]
- Definition: Specifies which party/parties will bear the charges associated with the processing of the payment transaction.
- Data Type: Code

Code	Name	Definition
SLEV	FollowingServiceLevel	FollowingServiceLevel Charges are to be applied following the rules agreed in the service level and/or scheme.

- Usage ISO: ChargeBearerRule
 If ChargeBearer is present, then DirectDebitTransactionInformation/ChargeBearer is not allowed.
 If DirectDebitTransactionInformation/ChargeBearer is present, then ChargeBearer is not allowed.

DirectDebitTransactionInformation/ChargeBearer and ChargeBearer may both be absent.

Usage EPC: Only 'SLEV' is allowed.

It is recommended that this element be specified at 'Payment Information' level.

2.25 ChargesAccount

Message Element that is not part of the addendum for the IG SDD Netherlands but is available for future use in a SEPA AOS.

2.26 ChargesAccountAgent

Message Element that is not part of the addendum for the IG SDD Netherlands but is available for FUTURE use in a SEPA AOS.

2.27 CreditorSchemeldentification

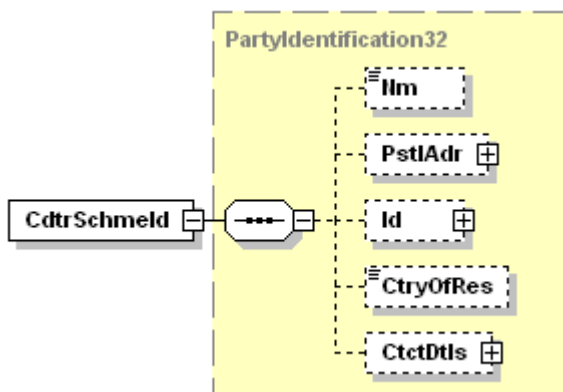

XML Tag: <CdtrSchmeld>

Occurence: [0..1], R4

Definition: Credit party that signs the mandate.

Type: This Message Item is composed of the following PartyIdentification32 element(s):

Or	Message Item	<XML Tag>	Mult.	Represent./Type
	Name	<Nm>	[0..1]	Text
	PostalAddress	<PstlAdr>	[0..1]	
	Identification	<Id>	[0..1]	
	CountryOfResidence	<CtryOfRes>	[0..1]	Code
	ContactDetails	<CtctDtls>	[0..1]	

Usage ISO: CreditorSchemeldentificationRule

If CreditorSchemeIdentification is present, then

DirectDebitTransactionInformation/CreditorSchemeIdentification is not allowed.

If DirectDebitTransactionInformation/CreditorSchemeIdentification is present, then CreditorSchemeIdentification is not allowed.

DirectDebitTransactionInformation/CreditorSchemeIdentification and CreditorSchemeIdentification may both be absent.

Usage EPC:

It is recommended that all transactions within the same 'Payment Information' block have the same 'Creditor Scheme Identification'.

The 'CreditorSchemeIdentification' data element must be present at either 'Payment Information' or 'Direct Debit Transaction' level.

'Identification' is Mandatory

'PrivateIdentification' is Mandatory. Private Identification is used to identify either an organisation or a private person.

Only one occurrence of 'Other' is allowed, and no other sub-elements are allowed.

Identification must be used with an identifier described in General Message Element 'Scheme Name' under 'Other' must specify 'SEPA' under 'Proprietary'.

Usage NL:

For an overview of the Creditor Scheme Identification NL structure see:

http://www.europeanpaymentscouncil.eu/knowledge_bank_download.cfm?file=EP C262-08 Creditor Identifier Overview v2.3.pdf

ATTENTION: Creditor Business Code (ZZZ) may not contain spaces.

2.28 DirectDebitTransactionInformation

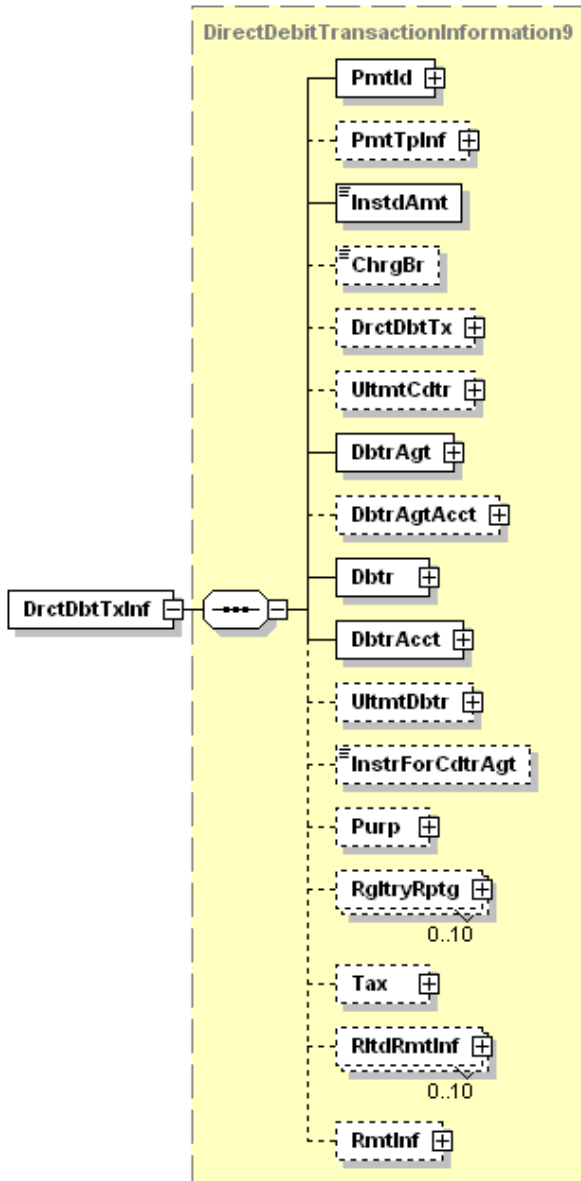

XML Tag: <DrctDbtTxlnf>

Occurence: [1..n]

Definition: Set of elements used to provide information on the individual transaction(s) included in the message.

Type: This Message Item is composed of the following DirectDebitTransactionInformation9 element(s):

Index	Or	Message Item	<XML Tag>	Mult.	Represent./Type
2.29		PaymentIdentification	<PmtId>	[1..1]	
2.32		PaymentTypeInformation	<PmtTplnf>	[0..1]	

2.44		InstructedAmount	<InstdAmt>	[1..1]	Amount
2.45		ChargeBearer	<ChrgBr>	[0..1]	Code
2.46		DirectDebitTransaction	<DrctDbtTx>	[0..1]	
2.69		UltimateCreditor	<UltmtCdtr>	[0..1]	+
2.70		DebtorAgent	<DbtrAgt>	[1..1]	+
2.71		DebtorAgentAccount	<DbtrAgtAcct>	[0..1]	+
2.72		Debtor	<Dbtr>	[1..1]	+
2.73		DebtorAccount	<DbtrAcct>	[1..1]	+
2.74		UltimateDebtor	<UltmtDbtr>	[0..1]	+
2.75		InstructionForCreditorAgent	<InstrForCdtrAgt>	[0..1]	Text
2.76		Purpose	<Purp>	[0..1]	
2.79		RegulatoryReporting	<RgltryRptg>	[0..10]	+
2.80		Tax	<Tax>	[0..1]	+
2.81		RelatedRemittanceInformation	<RltdRmtInf>	[0..10]	
2.88		RemittanceInformation	<RmtInf>	[0..1]	

Guideline(s): UltimateCreditorGuideline: UltimateCreditor may only be present if different from Creditor.

UltimateDebtorGuideline: UltimateDebtor may only be present if different from Debtor.

2.29 PaymentIdentification

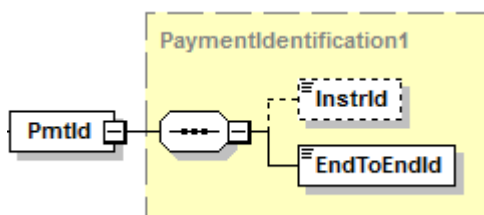

XML Tag: <PmtId>

Occurence: [1..1]

Definition: Set of elements used to reference a payment instruction.

Type: This Message Item is composed of the following PaymentIdentification1 element(s):

Index	Or	Message Item	<XML Tag>	Mult.	Represent./Type
2.30		InstructionIdentification	<InstrId>	[0..1]	Text
2.31		EndToEndIdentification	<EndToEndId>	[1..1]	Text

2.30 InstructionIdentification



XML Tag:	<InstrId>
Occurence:	[0..1]
Definition:	Unique identification as assigned by an instructing party for an instructed party to unambiguously identify the instruction.
Usage ISO:	The instruction identification is a point to point reference that can be used between the instructing party and the instructed party to refer to the individual instruction. It can be included in several messages related to the instruction.
Data Type:	Max35Text
Format:	maxLength: 35 minLength: 1

2.31 EndToEndIdentification

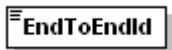

XML Tag:	<EndToEndId>
Occurence:	[1..1]
Definition:	Unique identification assigned by the initiating party to unambiguously identify the transaction. This identification is passed on, unchanged, throughout the entire end-to-end chain.
Usage ISO:	The end-to-end identification can be used for reconciliation or to link tasks relating to the transaction. It can be included in several messages related to the transaction.
Data Type:	Max35Text
Format:	maxLength: 35 minLength: 1

2.32 PaymentTypeInformation

Message Element that is not part of the addendum for the IG SDD Netherlands but is available for future use in a SEPA AOS.

2.33 InstructionPriority

Message Element that is not part of the addendum for the IG SDD Netherlands but is available for future use in a SEPA AOS.

2.34 ServiceLevel

Message Element that is not part of the addendum for the IG SDD Netherlands but is available for future use in a SEPA AOS.

2.35 Code

Message Element that is not part of the addendum for the IG SDD Netherlands but is available for future use in a SEPA AOS.

2.36 Proprietary

Message Element that is not part of the addendum for the IG SDD Netherlands but is available for future use in a SEPA AOS.

2.37 LocalInstrument

Message Element that is not part of the addendum for the IG SDD Netherlands but is available for future use in a SEPA AOS.

2.38 Code

Message Element that is not part of the addendum for the IG SDD Netherlands but is available for future use in a SEPA AOS.

2.39 Proprietary

Message Element that is not part of the addendum for the IG SDD Netherlands but is available for future use in a SEPA AOS.

2.40 SequenceType

Message Element that is not part of the addendum for the IG SDD Netherlands but is available for future use in a SEPA AOS.

2.41 CategoryPurpose

Message Element that is not part of the addendum for the IG SDD Netherlands but is available for future use in a SEPA AOS.

2.42 Code

Message Element that is not part of the addendum for the IG SDD Netherlands but is available for future use in a SEPA AOS.

2.43 Proprietary

Message Element that is not part of the addendum for the IG SDD Netherlands but is available for future use in a SEPA AOS.

2.44 InstructedAmount



XML Tag:	<InstdAmt>
Occurrence:	[1..1]
Definition:	Amount of money to be moved between the debtor and creditor, before deduction of charges, expressed in the currency as ordered by the initiating party.
Data Type:	ActiveOrHistoricCurrencyAndAmount This data type must be used with the following XML Attribute: Currency (Ccy) which is typed by ActiveOrHistoricCurrencyCode.
Format:	ActiveOrHistoricCurrencyAndAmount fractionDigits: 5 minInclusive: 0 totalDigits: 18 ActiveOrHistoricCurrencyCode [A-Z]{3,3}
Usage ISO:	ActiveOrHistoricCurrencyAndAmount CurrencyAmount The number of fractional digits (or minor unit of currency) must comply with ISO 4217. Note: The decimal separator is a dot. ActiveOrHistoricCurrencyCode ActiveOrHistoricCurrency The Currency Code must be registered, or have already been registered. Valid active or historic currency codes are registered with the ISO 4217 Maintenance Agency,

consist of three (3) contiguous letters, and may be or not be withdrawn on the day the message containing the Currency is exchanged.

Usage EPC: Only 'EUR' is allowed.
Amount must be 0.01 or more and 999999999.99 or less.
Format Rule: The fractional part has a maximum of two digits.

2.45 ChargeBearer

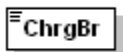

XML Tag: <ChrgBr>
Occurrence: [0..1], R1
Definition: Specifies which party/parties will bear the charges associated with the processing of the payment transaction.
Data Type: Code
Usage EPC: Only 'SLEV' is allowed.

Code	Name	Definition
SLEV	FollowingServiceLevel	FollowingServiceLevel Charges are to be applied following the rules agreed in the service level and/or scheme.

2.46 DirectDebitTransaction

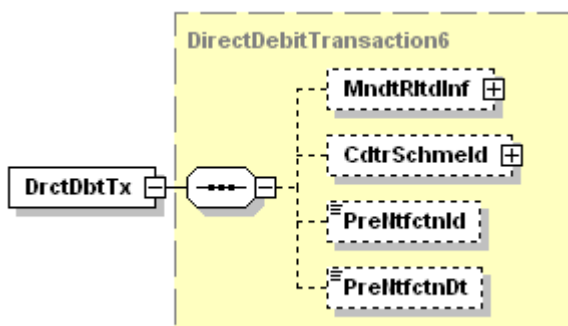

XML Tag: <DrctDbtTx>
Occurrence: [1..1]
Definition: Set of elements providing information specific to the direct debit mandate.
Type: This Message Item is composed of the following DirectDebitTransaction6 element(s):

Index	Or	Message Item	<XML Tag>	Mult.	Represent./Type
2.47		MandateRelatedInformation	<MndtRltdInf>	[0..1]	

2.66		CreditorSchemeldentification	<CdtrSchmeld>	[0..1]	+
2.67		PreNotificationIdentification	<PreNtfctnId>	[0..1]	Text
2.68		PreNotificationDate	<PreNtfctnDt>	[0..1]	DateTime

Usage EPC: Mandatory

2.47 MandateRelatedInformation

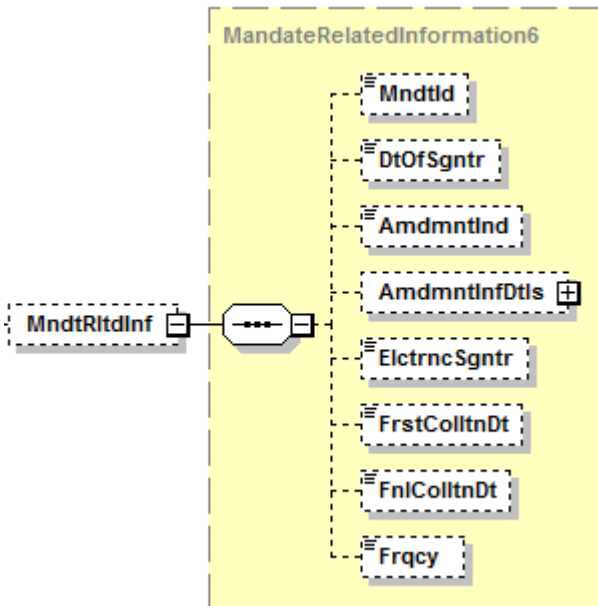

XML Tag: <MndtRltdInf>

Occurence: [1..1]

Definition: Set of elements used to provide further details of the direct debit mandate signed between the creditor and the debtor.

Type: This Message Item is composed of the following MandateRelatedInformation6 element(s):

Index	Or	Message Item	<XML Tag>	Mult.	Represent./Type
2.48		Mandatidentification	<MndtId>	[0..1]	Text
2.49		DateOfSignature	<DtOfSgntr>	[0..1]	DateTime
2.50		AmendmentIndicator	<AmdmntInd>	[0..1]	Indicator
2.51		AmendmentInformationDetails	<AmdmntInfDtIs>	[0..1]	
2.62		ElectronicSignature	<ElectrncSgntr>	[0..1]	Text
2.63		FirstCollectionDate	<FrstColltnDt>	[0..1]	Date
2.64		FinalCollectionDate	<FnlColltnDt>	[0..1]	Date
2.65		Frequency	<Frqcy>	[0..1]	Code

Usage ISO: AmendmentIndicatorFalseRule

If AmendmentIndicator is false, then AmendmentInformationDetails is not allowed.

AmendmentIndicatorTrueRule

If AmendmentIndicator is true, then AmendmentInformationDetails must be present.

Usage EPC: Mandatory

2.48 MandateIdentification

MndtId

XML Tag: <MndtId>

Occurrence: [1..1]

Definition: Unique identification, as assigned by the creditor, to unambiguously identify the mandate.

Data Type: Max35Text

Format: maxLength: 35
minLength: 1

Usage EPC: Mandatory

2.49 DateOfSignature

DtOfSgntr

XML Tag: <DtOfSgntr>

Occurrence: [1..1]

Definition: Date on which the direct debit mandate has been signed by the debtor.

Data Type: ISODate

Usage EPC: Mandatory

2.50 AmendmentIndicator

AmdmntInd

XML Tag: <AmdmntInd>

Occurrence: [0..1]

Definition: Indicator notifying whether the underlying mandate is amended or not.

Data Type: One of the following TrueFalseIndicator values must be used:

MeaningWhenTrue: True

MeaningWhenFalse: False

Example: <AmdmntInd>>false</AmdmntInd>

2.51 AmendmentInformationDetails

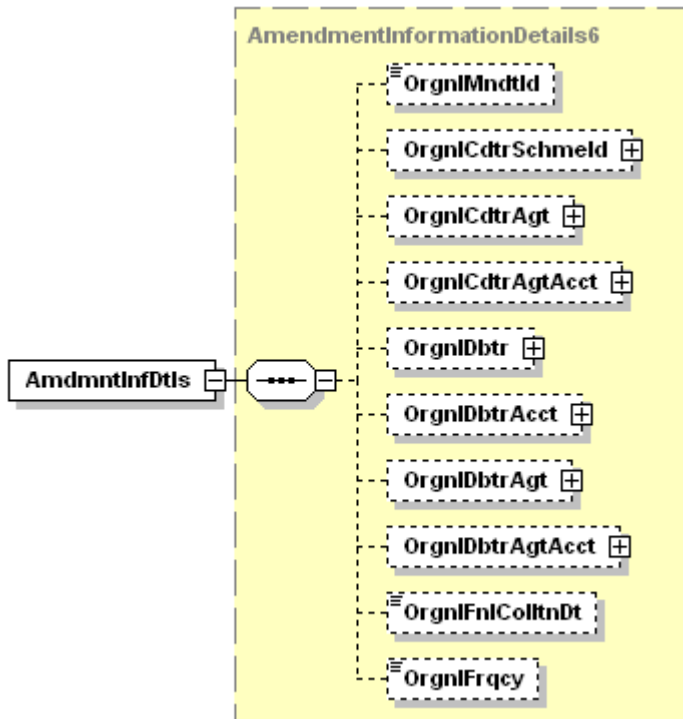

XML Tag: <AmdmntInfDtls>

Occurrence: [0..1]

Definition: List of mandate elements that have been modified.

Type: This Message Item is composed of the following AmendmentInformationDetails6 element(s):

Index	Or	Message Item	<XML Tag>	Mult.	Represent./Type
2.52		OriginalMandateIdentification	<OrgnlMndtId>	[0..1]	Text
2.53		OriginalCreditorSchemeIdentification	<OrgnlCdtrSchmeld>	[0..1]	+
2.54		OriginalCreditorAgent	<OrgnlCdtrAgt>	[0..1]	+
2.55		OriginalCreditorAgentAccount	<OrgnlCdtrAgtAcct>	[0..1]	+
2.56		OriginalDebtor	<OrgnlDbtr>	[0..1]	+
2.57		OriginalDebtorAccount	<OrgnlDbtrAcct>	[0..1]	+
2.58		OriginalDebtorAgent	<OrgnlDbtrAgt>	[0..1]	+
2.59		OriginalDebtorAgentAccount	<OrgnlDbtrAgtAcct>	[0..1]	+
2.60		OriginalFinalCollectionDate	<OrgnlFnlColltnDt>	[0..1]	DateTime

2.61		OriginalFrequency	<OrgnlFrqcy>	[0..1]	Code
------	--	-------------------	--------------	--------	------

Usage EPC: Mandatory if 'Amendment Indicator' is 'true'.
The reason code from the Rulebook is indicated using one of the following message sub-elements.

2.52 OriginalMandateIdentification

OrgnlMndtId

XML Tag: <OrgnlMndtId>
Occurence: [0..1]
Definition: Unique identification, as assigned by the creditor, to unambiguously identify the original mandate.
Data Type: Max35Text
Format: maxLength: 35
minLength: 1
Usage EPC: Mandatory if changes occur in 'Mandate Identification', otherwise not to be used.

2.53 OriginalCreditorSchemeIdentification

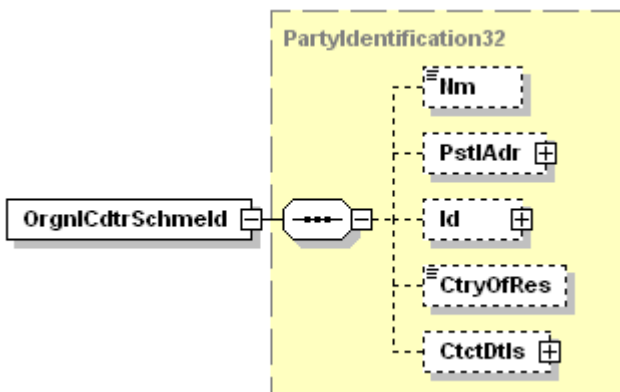

XML Tag: <OrgnlCdtrSchmeld>
Occurence: [0..1]
Definition: Original creditor scheme identification that has been modified.
Type: This Message Item is composed of the following PartyIdentification32 element(s):

Or	Message Item	<XML Tag>	Mult.	Represent./Type
	Name	<Nm>	[0..1]	Text
	PostalAddress	<PstlAdr>	[0..1]	
	Identification	<Id>	[0..1]	

	CountryOfResidence	<CtryOfRes>	[0..1]	Code
	ContactDetails	<CtctDtls>	[0..1]	

Usage EPC: 'OriginalCreditorSchemeIdentification' is Mandatory if changes occur in 'Creditor Scheme Identification' and or 'Name', otherwise not to be used.
 If 'Name' is present then the new 'Name' must be specified under 'Creditor'.
 'Name' is limited to 70 characters in length.
 Private Identification is used to identify either an organisation or a private person.
 Only one occurrence of 'Other' is allowed, and no other sub-elements are allowed.
 'Other' must be used with an identifier described in General Message Element
 'Scheme Name' under 'Other' must specify 'SEPA' under 'Proprietary'.

2.54 OriginalCreditorAgent

Message Element that is not part of the addendum for the IG SDD Netherlands but is available for future use in a SEPA AOS.

2.55 OriginalCreditorAgentAccount

Message Element that is not part of the addendum for the IG SDD Netherlands but is available for future use in a SEPA AOS.

2.56 OriginalDebtor

Message Element that is not part of the addendum for the IG SDD Netherlands but is available for future use in a SEPA AOS.

2.57 OriginalDebtorAccount

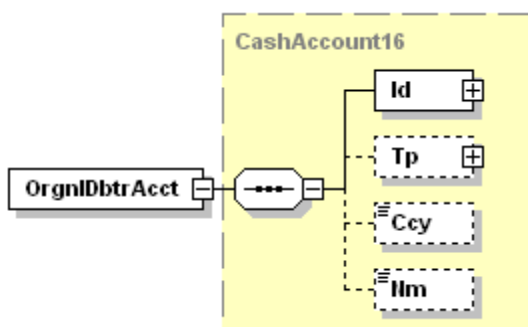

XML Tag: <OrgnlDbtrAcct>

Occurence: [0..1]

Definition: Original debtor account that has been modified.

Type: This Message Item is composed of the following CashAccount16 element(s):

Or	Message Item	<XML Tag>	Mult.	Represent./Type
	Identification	<Id>	[1..1]	
	Type	<Tp>	[0..1]	
	Currency	<Ccy>	[0..1]	Code
	Name	<Nm>	[0..1]	Text

Usage EPC: Only IBAN allowed.

To be used only for changes of accounts within the same bank.

2.58 OriginalDebtorAgent

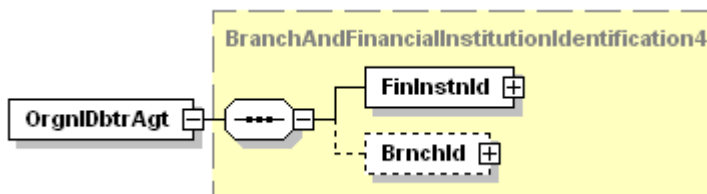

XML Tag: <OrgnIDbtrAgt>

Occurence: [0..1]

Definition: Original debtor agent that has been modified.

Type: This Message Item is composed of the following

BranchAndFinancialInstitutionIdentification4 element(s):

Or	Message Item	<XML Tag>	Mult.	Represent./Type
	FinancialInstitutionIdentification	<FinInstnId>	[1..1]	
	BranchIdentification	<BrnchId>	[0..1]	

Usage EPC: To use 'Identification' under 'Other' under 'Financial Institution Identification' with code 'SMNDA' to indicate same mandate with new Debtor Agent.

To be used with the 'FRST' indicator in the 'Sequence Type'.

2.59 OriginalDebtorAgentAccount

Message Element that is not part of the addendum for the IG SDD Netherlands but is available for future use in a SEPA AOS.

2.60 OriginalFinalCollectionDate

Message Element that is not part of the addendum for the IG SDD Netherlands but is available for future use in a SEPA AOS.

2.61 OriginalFrequency

Message Element that is not part of the addendum for the IG SDD Netherlands but is available for future use in a SEPA AOS.

2.62 ElectronicSignature



XML Tag:	<ElectronicSignature>
Occurrence:	[0..1]
Definition:	Additional security provisions, such as a digital signature, as provided by the debtor.
Data Type:	Max1025Text
Format:	maxLength: 1025 minLength: 1
Usage EPC:	If the direct debit is based on an EPC electronic mandate, this data element must contain AT-60 which is the reference to the Mandate Acceptance Report made by the Debtor Bank. This data element is not to be used if the mandate is a paper mandate.

2.63 FirstCollectionDate

Message Element that is not part of the addendum for the IG SDD Netherlands but is available for future use in a SEPA AOS.

2.64 FinalCollectionDate

Message Element that is not part of the addendum for the IG SDD Netherlands but is available for future use in a SEPA AOS.

2.65 Frequency

Message Element that is not part of the addendum for the IG SDD Netherlands but is available for future use in a SEPA AOS.

2.66 CreditorSchemeIdentification

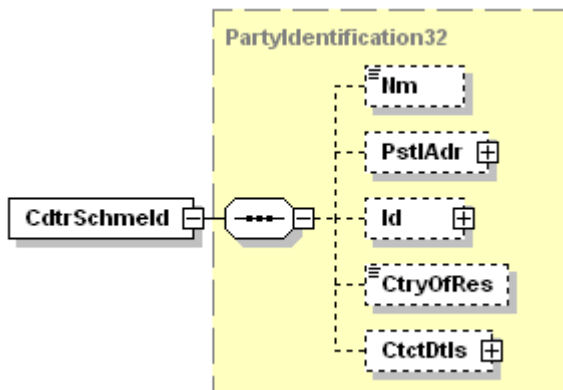

XML Tag: <CdtrSchmeld>

Occurence: [0..1]

Definition: Credit party that signs the mandate.

Type: This Message Item is composed of the following PartyIdentification32 element(s):

Or	Message Item	<XML Tag>	Mult.	Represent./Type
	Name	<Nm>	[0..1]	Text
	PostalAddress	<PstlAdr>	[0..1]	
	Identification	<Id>	[0..1]	
	CountryOfResidence	<CtryOfRes>	[0..1]	Code
	ContactDetails	<CtctDtls>	[0..1]	

Usage EPC: It is recommended that all transactions within the same 'Payment Information' block have the same 'Creditor Scheme Identification'.

The 'CreditorSchemeIdentification' data element must be present at either 'Payment Information' or 'Direct Debit Transaction' level.

'Identification' is Mandatory

'PrivateIdentification' is used to identify either an organisation or a private person.

Only one occurrence of 'Other' is allowed, and no other sub-elements are allowed.

'Other' must be used with an identifier described in General Message Element

'Scheme Name' under 'Other' must specify 'SEPA' under 'Proprietary'.

2.67 PreNotificationIdentification

Message Element that is not part of the addendum for the IG SDD Netherlands but is available for future use in a SEPA AOS.

2.68 PreNotificationDate

Message Element that is not part of the addendum for the IG SDD Netherlands but is available for future use in a SEPA AOS.

2.69 UltimateCreditor

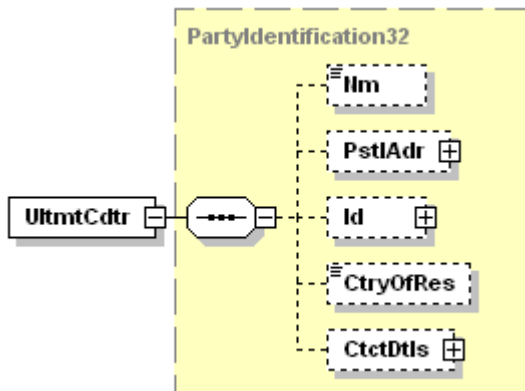

XML Tag: <UltmtCdtr>

Occurrence: [0..1], R5

Definition: Ultimate party to which an amount of money is due.

Type: This Message Item is composed of the following PartyIdentification32 element(s):

Or	Message Item	<XML Tag>	Mult.	Represent./Type
	Name	<Nm>	[0..1]	Text
	PostalAddress	<PstlAdr>	[0..1]	
	Identification	<Id>	[0..1]	
	CountryOfResidence	<CtryOfRes>	[0..1]	Code
	ContactDetails	<CtctDtls>	[0..1]	

Usage EPC: The 'UltimateCreditor' data element may be present either at 'Payment Information' or at 'Direct Debit Transaction Information' level.

'Name' is limited to 70 characters in length.

'OrganisationIdentification': Either 'BIC or BEI' or one occurrence of 'Other' is allowed.

'PrivateIdentification': 'Date and Place of Birth' or one occurrence of 'Other' is allowed.

2.70 DebtorAgent

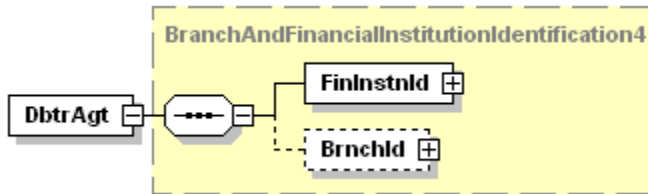

XML Tag: <DbtrAgt>

Occurence: [1..1]

Definition: Financial institution servicing an account for the debtor.

Type: This Message Item is composed of the following
BranchAndFinancialInstitutionIdentification4 element(s):

Or	Message Item	<XML Tag>	Mult.	Represent./Type
	FinancialInstitutionIdentification	<FinInstnId>	[1..1]	
	BranchIdentification	<BrnchId>	[0..1]	

Usage EPC: Either BIC or 'Other/Identification' must be used. When 'Other/Identification' is used, only 'NOTPROVIDED' is allowed in 'Identification'. The BIC is mandatory for EU/EEA cross border transactions until 31 January 2016.

Usage NL: Advise EPC usage rules effective per 1 January 2013 for NL domestic payments.

2.71 DebtorAgentAccount

Message Element that is not part of the addendum for the IG SDD Netherlands but is available for future use in a SEPA AOS.

2.72 Debtor

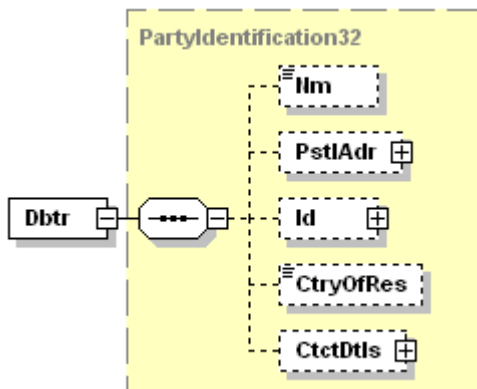

XML Tag: <Dbtr>

Occurence: [1..1]

Definition: Party that owes an amount of money to the (ultimate) creditor.

Type: This Message Item is composed of the following PartyIdentification32 element(s):

Or	Message Item	<XML Tag>	Mult.	Represent./Type
	Name	<Nm>	[0..1]	Text
	PostalAddress	<PstlAdr>	[0..1]	
	Identification	<Id>	[0..1]	
	CountryOfResidence	<CtryOfRes>	[0..1]	Code
	ContactDetails	<CtctDtls>	[0..1]	

Usage EPC: 'Name' is Mandatory.

'Name' is limited to 70 characters in length.

Only two occurrences of 'AddressLine' are allowed.

'OrganisationIdentification': Either 'BIC or BEI' or one occurrence of 'Other' is allowed.

'PrivateIdentification': Either 'Date and Place of Birth' or one occurrence of 'Other' is allowed.

In case of a mandate generated using data from a payment card at the point of sale which results in a direct debit to and from a payment account, and where the name of the Debtor is not available, the attribute "Name of the Debtor" must be filled in with "/CDGM" (note: Card Data Generated Mandate), followed by "/card number", "/sequence number" and "/expiry date of the card" (note: this means that the information parts are delimited by "/") or, if these data elements are not available, by any other data element(s) that would uniquely identify the Debtor to the Debtor Bank. This is only applicable in case Local Instrument is 'COR' or 'COR1'.

2.73 DebtorAccount

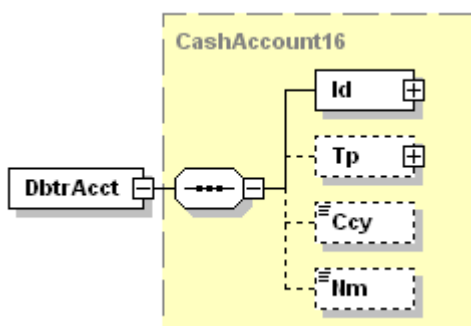

XML Tag: <DbtrAcct>

Occurence: [1..1]

Definition: Unambiguous identification of the account of the debtor to which a debit entry will be made as a result of the transaction.

Type: This Message Item is composed of the following CashAccount16 element(s):

Or	Message Item	<XML Tag>	Mult.	Represent./Type
	Identification	<Id>	[1..1]	
	Type	<Tp>	[0..1]	
	Currency	<Ccy>	[0..1]	Code
	Name	<Nm>	[0..1]	Text

Usage EPC: Only IBAN is allowed.

2.74 UltimateDebtor

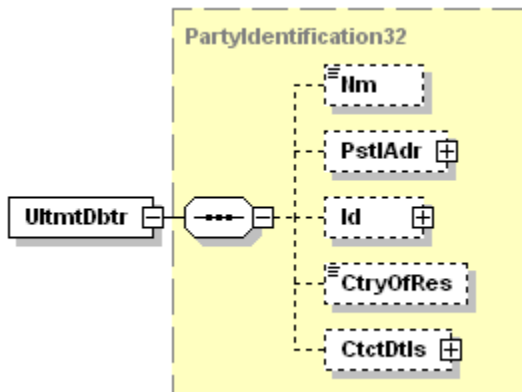

XML Tag: <UltmtDbtr>

Occurence: [0..1]

Definition: Ultimate party that owes an amount of money to the (ultimate) creditor.

Type: This Message Item is composed of the following PartyIdentification32 element(s):

Or	Message Item	<XML Tag>	Mult.	Represent./Type
	Name	<Nm>	[0..1]	Text
	PostalAddress	<PstlAdr>	[0..1]	
	Identification	<Id>	[0..1]	
	CountryOfResidence	<CtryOfRes>	[0..1]	Code
	ContactDetails	<CtctDtIs>	[0..1]	

Usage EPC: 'UltimateDebtor' is Mandatory, if provided by the Debtor in the Mandate.

'Name' is limited to 70 characters in length.

'Name' is Mandatory if provided by the Debtor in the mandate.

'OrganisationIdentification': Either 'BIC or BEI' or one occurrence of 'Other' is allowed.

'Privatidentification': Either 'Date and Place of Birth' or one occurrence of 'Other' is allowed.

2.75 InstructionForCreditorAgent

Message Element that is not part of the addendum for the IG SDD Netherlands but is available for future use in a SEPA AOS.

2.76 Purpose

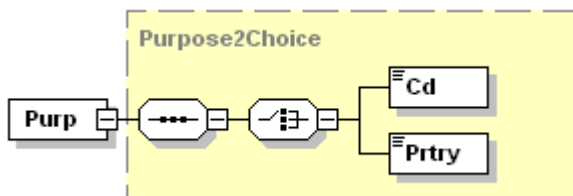

XML Tag: <Purp>

Occurence: [0..1]

Definition: Underlying reason for the payment transaction.

Usage ISO: Purpose is used by the end-customers, that is initiating party, (ultimate) debtor, (ultimate) creditor to provide information concerning the nature of the payment. Purpose is a content element, which is not used for processing by any of the agents involved in the payment chain.

Type: This Message Item is composed of one of the following Purpose2Choice element(s):

Index	Or	Message Item	<XML Tag>	Mult.	Represent./Type
2.77	{Or	Code	<Cd>	[1..1]	Code
2.78	Or}	Proprietary	<Prtry>	[1..1]	Text

2.77 Code

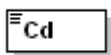

XML Tag: <Cd>

Occurence: [1..1]

This Message Item is part of choice 2.76 Purpose.

Definition: Underlying reason for the payment transaction, as published in an external purpose code list.

Data Type: ExternalPurpose1Code

Format: maxLength: 4

minLength: 1

2.78 Proprietary

Message Element that is not part of the addendum for the IG SDD Netherlands but is available for future use in a SEPA AOS.

2.79 RegulatoryReporting

Message Element that is not part of the addendum for the IG SDD Netherlands but is available for future use in a SEPA AOS.

2.80 Tax

Message Element that is not part of the addendum for the IG SDD Netherlands but is available for future use in a SEPA AOS.

2.81 RelatedRemittanceInformation

Message Element that is not part of the addendum for the IG SDD Netherlands but is available for future use in a SEPA AOS.

2.82 RemittanceIdentification

Message Element that is not to be used in SEPA Payments for NL.

2.83 RemittanceLocationMethod

Message Element that is not to be used in SEPA Payments for NL.

2.85 RemittanceLocationPostalAddress

Message Element that is not to be used in SEPA Payments for NL.

2.86 Name

Message Element that is not to be used in SEPA Payments for NL.

2.87 Address

Message Element that is not to be used in SEPA Payments for NL.

2.88 RemittanceInformation

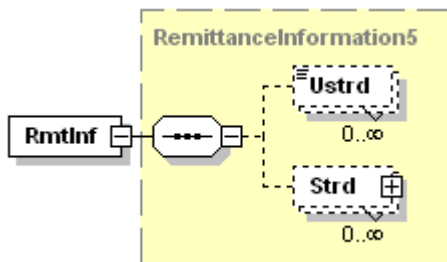

XML Tag: <RmtInf>

Occurrence: [0..1]

Definition: Information supplied to enable the matching of an entry with the items that the transfer is intended to settle, such as commercial invoices in an accounts' receivable system.

Type: This Message Item is composed of the following RemittanceInformation5 element(s):

Index	Or	Message Item	<XML Tag>	Mult.	Represent./Type
2.89		Unstructured	<Ustrd>	[0..n]	Text
2.90		Structured	<Strd>	[0..n]	

Usage EPC: Either 'Structured' or 'Unstructured', may be present.

2.89 Unstructured

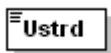

XML Tag: <Ustrd>

Occurrence: [0..n]

Definition: Information supplied to enable the matching/reconciliation of an entry with the items that the payment is intended to settle, such as commercial invoices in an accounts' receivable system, in an unstructured form.

Data Type: Max140Text

Format: maxLength: 140
minLength: 1

Usage EPC: 'Unstructured' may carry structured remittance information, as agreed between the Creditor and the Debtor.

Format Rule: Only one occurrence of 'Unstructured' is allowed.

2.90 Structured

NL usage rule: Use End 2 End Identification if free text containing a specification of the payment used.

2.91 ReferredDocumentInformation

Message Element that is not part of the addendum for the IG SDD Netherlands but is available for future use in a SEPA AOS.

2.92 Type

Message Element that is not to be used in SEPA Payments for NL.

2.93 CodeOrProprietary

Message Element that is not to be used in SEPA Payments for NL.

2.94 Code

Message Element that is not to be used in SEPA Payments for NL.

2.95 Proprietary

Message Element that is not to be used in SEPA Payments for NL.

2.96 Issuer

Message Element that is not to be used in SEPA Payments for NL.

2.97 Number

Message Element that is not to be used in SEPA Payments for NL.

2.98 RelatedDate

Message Element that is not to be used in SEPA Payments for NL.

2.99 ReferredDocumentAmount

Message Element that is not part of the addendum for the IG SDD Netherlands but is available for future use in a SEPA AOS.

2.100 DuePayableAmount

Message Element that is not to be used in SEPA Payments for NL.

2.101 DiscountAppliedAmount

Message Element that is not to be used in SEPA Payments for NL.

2.102 CreditNoteAmount

Message Element that is not to be used in SEPA Payments for NL.

2.103 TaxAmount

Message Element that is not to be used in SEPA Payments for NL.

2.104 AdjustmentAmountAndReason

Message Element that is not to be used in SEPA Payments for NL.

2.105 Amount

Message Element that is not to be used in SEPA Payments for NL.

2.106 CreditDebitIndicator

Message Element that is not to be used in SEPA Payments for NL.

2.107 Reason

Message Element that is not to be used in SEPA Payments for NL.

2.108 AdditionalInformation

Message Element that is not to be used in SEPA Payments for NL.

2.109 RemittedAmount

Message Element that is not to be used in SEPA Payments for NL.

2.110 CreditorReferenceInformation

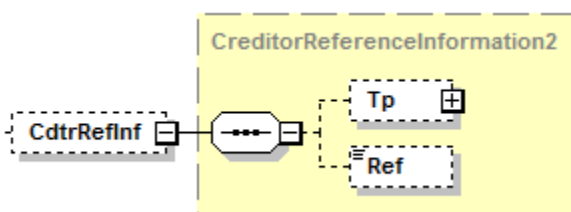

XML Tag: <CdtrRefInf>

Occurence: [0..1]

Definition: Reference information provided by the creditor to allow the identification of the underlying documents.

Type: This Message Item is composed of the following CreditorReferenceInformation2 element(s):

Index	Or	Message Item	<XML Tag>	Mult.	Represent./Type
2.111		Type	<Tp>	[0..1]	
2.116		Reference	<Ref>	[0..1]	Text

Usage EPC: When present, the Creditor Bank is not obliged to validate the reference information. When used, both 'Type' and 'Reference' must be present.

2.111 Type

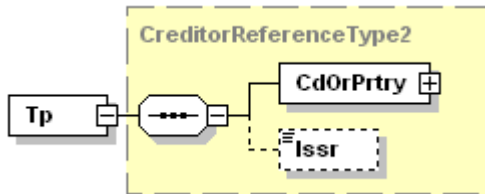

XML Tag: <Tp>

Occurence: [0..1]

Definition: Specifies the type of creditor reference.

Type: This Message Item is composed of the following CreditorReferenceType2 element(s):

Index	Or	Message Item	<XML Tag>	Mult.	Represent./Type
2.112		CodeOrProprietary	<CdOrPrtry>	[1..1]	
2.115		Issuer	<Issr>	[0..1]	Text

2.112 CodeOrProprietary

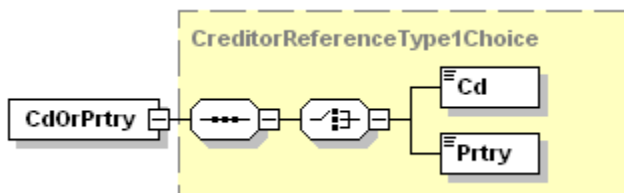

XML Tag: <CdOrPrtry>

Occurence: [1..1]

Definition: Coded or proprietary format creditor reference type.

Type: This Message Item is composed of one of the following
CreditorReferenceType1Choice element(s):

Index	Or	Message Item	<XML Tag>	Mult.	Represent./Type
2.113	{Or	Code	<Cd>	[1..1]	Code
2.114	Or}	Proprietary	<Prtry>	[1..1]	Text

2.113 Code

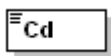

XML Tag: <Cd>

Occurence: [1..1]

This Message Item is part of choice 2.112 CodeOrProprietary.

Definition: Type of creditor reference, in a coded form.

Data Type: Code

Usage EPC: Only 'SCOR' is allowed.

Code	Name	Definition
SCOR	StructuredCommunicationReference	Document is a structured communication reference provided by the creditor to identify the referred transaction.

2.114 Proprietary

Message Element that is not part of the addendum for the IG SDD Netherlands but is available for future use in a SEPA AOS.

2.115 Issuer

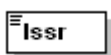

XML Tag: <Issr>

Occurence: [0..1]

Definition: Entity that assigns the credit reference type.

Data Type: Max35Text
Format: maxLength: 35
minLength: 1
Usage NL: If the Dutch Structured Communication is used the following value must be used as Issuer "CUR".

2.116 Reference



XML Tag: <Ref>
Occurrence: [0..1]
Definition: Unique reference, as assigned by the creditor, to unambiguously refer to the payment transaction.
Usage ISO: If available, the initiating party should provide this reference in the structured remittance information, to enable reconciliation by the creditor upon receipt of the amount of money.
If the business context requires the use of a creditor reference or a payment remit identification, and only one identifier can be passed through the end-to-end chain, the creditor's reference or payment remittance identification should be quoted in the end-to-end transaction identification.
Data Type: Max35Text

Format: maxLength: 35

 minLength: 1

Usage EPC: If 'Creditor' Reference contains a check digit, the receiving bank is not required to validate this.

 If the receiving bank validates the check digit and if this validation fails, the bank may continue its processing and send the transaction to the next party in the chain.

 RF Creditor Reference may be used (ISO 11649)

Usage NL: If the Dutch Structured Communication is used (indicated through the issuer value "CUR") the reference must be compliant with the rules for the structured Communication ("Betalingsskenmerk").

2.117 Invoicer

Message Element that is not part of the addendum for the IG SDD Netherlands but is available for future use in a SEPA AOS.

2.118 Invoicee

Message Element that is not part of the addendum for the IG SDD Netherlands but is available for future use in a SEPA AOS.

2.119 AdditionalRemittanceInformation

Message Element that is not part of the addendum for the IG SDD Netherlands but is available for future use in a SEPA AOS.

Annex A Detailed message item overview

The following table provides a summary of the message items to be used for a SEPA Direct Debit.

A more detailed description of each message item is given in the Message items description.

Only the message items that are in scope for this IG are presented.

<i>Index</i>	<i>Generic ISO Index</i>	<i>Or</i>	<i>Message Item</i>	<i><XML Tag></i>	<i>Mult.</i>	<i>Type</i>
0.0			+Message root	<CstmrDrctDbtInitn>	[1..1]	
1.0			+GroupHeader	<GrpHdr>	[1..1]	
1.1			++MessageIdentification	<MsgId>	[1..1]	Text
1.2			++CreationDateTime	<CreDtTm>	[1..1]	DateTime
1.6			++NumberOfTransactions	<NbOfTx>	[1..1]	Text
1.7			++ControlSum	<CtrlSum>	[0..1]	Quantity
1.8			++InitiatingParty	<InitgPty>	[1..1]	+
1.8	9.1.0		+++Name	<Nm>	[0..1]	Text
1.8	9.1.12		+++Identification	<Id>	[0..1]	
1.8	9.1.13	{Or	++++OrganisationIdentification	<OrgId>	[1..1]	
1.8	9.1.14		+++++BICOrBEI	<BICOrBEI>	[0..1]	Identifier
1.8	9.1.15		+++++Other	<Othr>	[0..n]	
1.8	9.1.16		+++++Identification	<Id>	[1..1]	Text
1.8	9.1.17		+++++SchemeName	<SchmeNm>	[0..1]	
1.8	9.1.18	{{Or	+++++Code	<Cd>	[1..1]	Code
1.8	9.1.19	Or}}	+++++Proprietary	<Prtry>	[1..1]	Text
1.8	9.1.20		+++++Issuer	<Issr>	[0..1]	Text
1.8	9.1.21	Or}	++++PrivateIdentification	<PrvtId>	[1..1]	
1.8	9.1.22		+++++DateAndPlaceOfBirth	<DtAndPlcOfBirth>	[0..1]	
1.8	9.1.23		+++++BirthDate	<BirthDt>	[1..1]	DateTime
1.8	9.1.24		+++++ProvinceOfBirth	<PrvcOfBirth>	[0..1]	Text
1.8	9.1.25		+++++CityOfBirth	<CityOfBirth>	[1..1]	Text
1.8	9.1.26		+++++CountryOfBirth	<CtryOfBirth>	[1..1]	Code
1.8	9.1.27		+++++Other	<Othr>	[0..n]	
1.8	9.1.28		+++++Identification	<Id>	[1..1]	Text
1.8	9.1.29		+++++SchemeName	<SchmeNm>	[0..1]	

Index	Generic ISO Index	Or	Message Item	<XML Tag>	Mult.	Type
1.8	9.1.30	{Or	+++++Code	<Cd>	[1..1]	Code
1.8	9.1.31	Or}}	+++++Proprietary	<Prtry>	[1..1]	Text
1.8	9.1.32		+++++Issuer	<Issr>	[0..1]	Text
2.0			++PaymentInformation	<PmtInf>	[1..n]	
2.1			++PaymentInformationIdentification	<PmtInfId>	[1..1]	Text
2.2			++PaymentMethod	<PmtMtd>	[1..1]	Code
2.3			++BatchBooking	<BtchBookg>	[0..1]	Indicator
2.4			++NumberOfTransactions	<NbOfTx>	[0..1]	Text
2.5			++ControlSum	<CtrlSum>	[0..1]	Quantity
2.6			++PaymentTypeInformation	<PmtTplnf>	[0..1]	
2.8			+++ServiceLevel	<SvcLvl>	[0..1]	
2.9		{Or	++++Code	<Cd>	[1..1]	Code
2.11			+++LocalInstrument	<LclInstrm>	[0..1]	
2.12		{Or	++++Code	<Cd>	[1..1]	Code
2.14			+++SequenceType	<SeqTp>	[0..1]	Code
2.15			+++CategoryPurpose	<CtgyPurp>	[0..1]	
2.16		{Or	++++Code	<Cd>	[1..1]	Code
2.17		Or}	++++Proprietary	<Prtry>	[1..1]	Text
2.18			++RequestedCollectionDate	<ReqdColltnDt>	[1..1]	ISODate
2.19			+++Creditor	<Cdtr>	[0..1]	+
2.19	9.1.0		++++Name	<Nm>	[0..1]	Text
2.19	9.1.1		++++PostalAddress	<PstlAdr>	[0..1]	
2.19	9.1.10		+++++Country	<Ctry>	[0..1]	Code
2.19	9.1.11		+++++AddressLine	<AdrLine>	[0..7]	Text
2.19	9.1.13		++++Identification	<Id>	[0..1]	
2.19	9.1.33		++++CountryOfResidence	<CtryOfRes>	[0..1]	
2.19	9.1.34		++++ContactDetails	<CtctDtls>	[0..1]	
2.20			+++CreditorAccount	<CdtrAcct>	[0..1]	+
2.20	1.1.0		+++Identification	<Id>	[1..1]	
2.20	1.1.1	{Or	++++IBAN	<IBAN>	[1..1]	Identifier
2.21			+++CreditorAgent	<CdtrAgt>	[0..1]	+
2.21	6.1.0		++++FinancialInstitutionIdentification	<FinInstnId>	[1..1]	

Index	Generic ISO Index	Or	Message Item	<XML Tag>	Mult.	Type
2.21	6.1.1	{Or	+++++BIC	<BIC>	[0..1]	Identifier
2.21	6.1.19	Or}	++++ Other	<Othr>	[0..1]	
2.21	6.1.20		+++++ Identification	<Id>	[1..1]	Text
2.23			+++UltimateCreditor	<UltmtCdtr>	[0..1]	+
2.23	9.1.0		++++Name	<Nm>	[0..1]	Text
2.23	9.1.12		++++Identification	<Id>	[0..1]	
2.23	9.1.13	{Or	+++++OrganisationIdentification	<Orgld>	[1..1]	
2.23	9.1.14		+++++BICorBEI	<BICorBEI>	[0..1]	Identifier
2.23	9.1.15		+++++Other	<Othr>	[0..n]	
2.23	9.1.16		+++++Identification	<Id>	[1..1]	Text
2.23	9.1.17		+++++SchemeName	<SchmeNm>	[0..1]	
2.23	9.1.18	{{Or	+++++Code	<Cd>	[1..1]	Code
2.23	9.1.19	Or}}	+++++Proprietary	<Prtry>	[1..1]	Text
2.23	9.1.20		+++++Issuer	<Issr>	[0..1]	Text
2.23	9.1.21	Or}	+++++PrivateIdentification	<PrvtId>	[1..1]	
2.23	9.1.22		+++++DateAndPlaceOfBirth	<DtAndPlcOfBirth>	[0..1]	
2.23	9.1.23		+++++BirthDate	<BirthDt>	[1..1]	Date
2.23	9.1.24		+++++ProvinceOfBirth	<PrvcOfBirth>	[0..1]	Text
2.23	9.1.25		+++++CityOfBirth	<CityOfBirth>	[1..1]	Text
2.23	9.1.26		+++++CountryOfBirth	<CtryOfBirth>	[1..1]	Code
2.23	9.1.27		+++++Other	<Othr>	[0..n]	
2.23	9.1.28		+++++Identification	<Id>	[1..1]	Text
2.23	9.1.29		+++++SchemeName	<SchmeNm>	[0..1]	
2.23	9.1.30	{{Or	+++++Code	<Cd>	[1..1]	Code
2.23	9.1.31	Or}}	+++++Proprietary	<Prtry>	[1..1]	Text
2.23	9.1.32		+++++Issuer	<Issr>	[0..1]	Text
2.24			++ChargeBearer	<ChrgBr>	[0..1]	Code
2.27			++CreditorSchemeIdentification	<CdtrSchmeld>	[0..1]	+
2.27	9.1.12		++++Identification	<Id>	[0..1]	
2.27	9.1.21	Or}	+++++PrivateIdentification	<PrvtId>	[1..1]	
2.27	9.1.27		+++++Other	<Othr>	[0..n]	
2.27	9.1.28		+++++Identification	<Id>	[1..1]	Text

Index	Generic ISO Index	Or	Message Item	<XML Tag>	Mult.	Type
2.27	9.1.29		+++++SchemeName	<SchmeNm>	[0..1]	
2.27	9.1.30	{{Or	+++++Code	<Cd>	[1..1]	Code
2.27	9.1.31	Or}}	+++++Proprietary	<Prtry>	[1..1]	Text
2.27	9.1.32		+++++Issuer	<Issr>	[0..1]	Text
2.28			++DirectDebitTransactionInformation	<DrctDbtTxInf>	[1..n]	
2.29			+++PaymentIdentification	<PmtId>	[1..1]	
2.30			++++InstructionIdentification	<InstrId>	[0..1]	Text
2.31			++++EndToEndIdentification	<EndToEndId>	[1..1]	Text
2.44			+++InstructedAmount	<InstdAmt>	[1..1]	Amount
2.45			+++ChargeBearer	<ChrgBr>	[0..1]	Code
2.46			+++DirectDebitTransaction	<DrctDbtTx>	[0..1]	
2.47			++++MandateRelatedInformation	<MndtRltdInf>	[0..1]	
2.48			++++MandatIdentification	<MndtId>	[0..1]	Text
2.49			++++DateOfSignature	<DtOfSgntr>	[0..1]	DateTime
2.50			++++AmendmentIndicator	<AmdmntInd>	[0..1]	Indicator
2.51			++++AmendmentInformationDetails	<AmdmntInfDtls>	[0..1]	
2.52			++++OriginalMandatIdentification	<OrgnlMndtId>	[0..1]	Text
2.53			++++OriginalCreditorSchemeIdentification	<OrgnlCdtrSchmeId>	[0..1]	+
2.53	9.1.0		+++++Name	<Nm>	[0..1]	Text
2.53	9.1.12		+++++Identification	<Id>	[0..1]	
2.53	9.1.21	Or}	+++++PrivateIdentification	<PrvtId>	[1..1]	
2.53	9.1.27		+++++Other	<Othr>	[0..n]	
2.53	9.1.28		+++++Identification	<Id>	[1..1]	Text
2.53	9.1.29		+++++SchemeName	<SchmeNm>	[0..1]	
2.53	9.1.30	{{Or	+++++Code	<Cd>	[1..1]	Code
2.53	9.1.31	Or}}	+++++Proprietary	<Prtry>	[1..1]	Text
2.53	9.1.32		+++++Issuer	<Issr>	[0..1]	Text
2.57			++++OriginalDebtorAccount	<OrgnlDbtrAcct>	[0..1]	+
2.57	1.1.0		+++++Identification	<Id>	[1..1]	
2.57	1.1.1	{Or	+++++IBAN	<IBAN>	[1..1]	Identifier
2.58			++++OriginalDebtorAgent	<OrgnlDbtrAgt>	[0..1]	+
2.58	6.1.0		+++++FinancialInstitutionIdentification	<FinInstnId>	[1..1]	

Index	Generic ISO Index	Or	Message Item	<XML Tag>	Mult.	Type
2.58	6.1.19		+++++++Other	<Othr>	[0..1]	
2.58	6.1.20		+++++++Identification	<Id>	[1..1]	Text
2.62			+++++ElectronicSignature	<ElctrcSgntr>	[0..1]	Text
2.66			+++++CreditorSchemeIdentification	<CdtrSchmeld>	[0..1]	+
2.66	9.1.12		+++++Identification	<Id>	[0..1]	
2.66	9.1.21	Or}	+++++++PrivateIdentification	<PrvtId>	[1..1]	
2.66	9.1.27		+++++++Other	<Othr>	[0..n]	
2.66	9.1.28		+++++++Identification	<Id>	[1..1]	Text
2.66	9.1.29		+++++++SchemeName	<SchmeNm>	[0..1]	
2.66	9.1.30	{{Or	+++++++Code	<Cd>	[1..1]	Code
2.69			+++++UltimateCreditor	<UltmtCdtr>	[0..1]	+
2.69	9.1.0		+++++Name	<Nm>	[0..1]	Text
2.69	9.1.12		+++++Identification	<Id>	[0..1]	
2.69	9.1.13	{Or	+++++OrganisationIdentification	<Orgld>	[1..1]	
2.69	9.1.14		+++++BICOrBEI	<BICOrBEI>	[0..1]	Identifier
2.69	9.1.15		+++++Other	<Othr>	[0..n]	
2.69	9.1.16		+++++++Identification	<Id>	[1..1]	Text
2.69	9.1.17		+++++++SchemeName	<SchmeNm>	[0..1]	
2.69	9.1.18	{{Or	+++++++Code	<Cd>	[1..1]	Code
2.69	9.1.19	Or}}	+++++++Proprietary	<Prtry>	[1..1]	Text
2.69	9.1.20		+++++++Issuer	<Issr>	[0..1]	Text
2.69	9.1.21	Or}	+++++PrivateIdentification	<PrvtId>	[1..1]	
2.69	9.1.22		+++++++DateAndPlaceOfBirth	<DtAndPlcOfBirth>	[0..1]	
2.69	9.1.23		+++++++BirthDate	<BirthDt>	[1..1]	Date
2.69	9.1.24		+++++++ProvinceOfBirth	<PrvcOfBirth>	[0..1]	Text
2.69	9.1.25		+++++++CityOfBirth	<CityOfBirth>	[1..1]	Text
2.69	9.1.26		+++++++CountryOfBirth	<CtryOfBirth>	[1..1]	Code
2.69	9.1.27		+++++Other	<Othr>	[0..n]	
2.69	9.1.28		+++++++Identification	<Id>	[1..1]	Text
2.69	9.1.29		+++++++SchemeName	<SchmeNm>	[0..1]	
2.69	9.1.30	{{Or	+++++++Code	<Cd>	[1..1]	Code
2.69	9.1.31	Or}}	+++++++Proprietary	<Prtry>	[1..1]	Text

Index	Generic ISO Index	Or	Message Item	<XML Tag>	Mult.	Type
2.69	9.1.32		+++++Issuer	<Issr>	[0..1]	Text
2.70			++++DebtorAgent	<DbtrAgt>	[1..1]	+
2.70	6.1.0		+++++FinancialInstitutionIdentification	<FinInstnId>	[1..1]	
2.70	6.1.1	{Or	+++++BIC	<BIC>	[0..1]	Identifier
2.70	6.1.19	Or}	+++++Other	<Othr>	[0..1]	
2.70	6.1.20		+++++Identification	<Id>	[1..1]	Text
2.72			++++Debtor	<Dbtr>	[1..1]	+
2.72	9.1.0		+++++Name	<Nm>	[0..1]	Text
2.72	9.1.1		+++++PostalAddress	<PstlAdr>	[0..1]	
2.72	9.1.10		+++++Country	<Ctry>	[0..1]	Code
2.72	9.1.11		+++++AddressLine	<AdrLine>	[0..7]	Text
2.72	9.1.12		+++++Identification	<Id>	[0..1]	
2.72	9.1.13	{Or	+++++OrganisationIdentification	<OrgId>	[1..1]	
2.72	9.1.14		+++++BICOrBEI	<BICOrBEI>	[0..1]	Identifier
2.72	9.1.15		+++++Other	<Othr>	[0..n]	
2.72	9.1.16		+++++Identification	<Id>	[1..1]	Text
2.72	9.1.17		+++++SchemeName	<SchmeNm>	[0..1]	
2.72	9.1.18	{{Or	+++++Code	<Cd>	[1..1]	Code
2.72	9.1.19	Or}}	+++++Proprietary	<Prtry>	[1..1]	Text
2.72	9.1.20		+++++Issuer	<Issr>	[0..1]	Text
2.72	9.1.21	Or}	+++++PrivateIdentification	<PrvtId>	[1..1]	
2.72	9.1.22		+++++DateAndPlaceOfBirth	<DtAndPlcOfBirth>	[0..1]	
2.72	9.1.23		+++++BirthDate	<BirthDt>	[1..1]	Date
2.72	9.1.24		+++++ProvinceOfBirth	<PrvcOfBirth>	[0..1]	Text
2.72	9.1.25		+++++CityOfBirth	<CityOfBirth>	[1..1]	Text
2.72	9.1.26		+++++CountryOfBirth	<CtryOfBirth>	[1..1]	Code
2.72	9.1.27		+++++Other	<Othr>	[0..n]	
2.72	9.1.28		+++++Identification	<Id>	[1..1]	Text
2.72	9.1.29		+++++SchemeName	<SchmeNm>	[0..1]	
2.72	9.1.30	{{Or	+++++Code	<Cd>	[1..1]	Code
2.72	9.1.31	Or}}	+++++Proprietary	<Prtry>	[1..1]	Text
2.72	9.1.32		+++++Issuer	<Issr>	[0..1]	Text

Index	Generic ISO Index	Or	Message Item	<XML Tag>	Mult.	Type
2.73			++++DebtorAccount	<DbtrAcct>	[1..1]	+
2.73	1.1.0		++++Identification	<Id>	[1..1]	
2.73	1.1.1	{Or	+++++IBAN	<IBAN>	[1..1]	Identifier
2.73	1.1.11		+++++Currency	<Ccy>	[0..1]	Code
2.74			++++UltimateDebtor	<UltmtDbtr>	[0..1]	+
2.74	9.1.0		+++++Name	<Nm>	[0..1]	Text
2.74	9.1.12		+++++Identification	<Id>	[0..1]	
2.74	9.1.13	{Or	+++++OrganisationIdentification	<OrgId>	[1..1]	
2.75	9.1.14		+++++BICOrBEI	<BICOrBEI>	[0..1]	Identifier
2.75	9.1.15		+++++Other	<Othr>	[0..n]	
2.75	9.1.16		+++++Identification	<Id>	[1..1]	Text
2.75	9.1.17		+++++SchemeName	<SchmeNm>	[0..1]	
2.75	9.1.18	{{Or	+++++Code	<Cd>	[1..1]	Code
2.75	9.1.19	Or}}	+++++Proprietary	<Prtry>	[1..1]	Text
2.75	9.1.20		+++++Issuer	<Issr>	[0..1]	Text
2.75	9.1.21	Or}	+++++PrivateIdentification	<PrvtId>	[1..1]	
2.75	9.1.22		+++++DateAndPlaceOfBirth	<DtAndPlcOfBirth>	[0..1]	
2.75	9.1.23		+++++BirthDate	<BirthDt>	[1..1]	Date
2.75	9.1.24		+++++ProvinceOfBirth	<PrvcOfBirth>	[0..1]	Text
2.75	9.1.25		+++++CityOfBirth	<CityOfBirth>	[1..1]	Text
2.75	9.1.26		+++++CountryOfBirth	<CtryOfBirth>	[1..1]	Code
2.75	9.1.27		+++++Other	<Othr>	[0..n]	
2.75	9.1.28		+++++Identification	<Id>	[1..1]	Text
2.76	9.1.29		+++++SchemeName	<SchmeNm>	[0..1]	
2.76	9.1.30	{{Or	+++++Code	<Cd>	[1..1]	Code
2.76	9.1.31	Or}}	+++++Proprietary	<Prtry>	[1..1]	Text
2.76	9.1.32		+++++Issuer	<Issr>	[0..1]	Text
2.76			++++Purpose	<Purp>	[0..1]	
2.77		{Or	++++Code	<Cd>	[1..1]	
2.88			++++RemittanceInformation	<RmtInf>	[0..1]	
2.89			++++Unstructured	<Ustrd>	[0..n]	Text
2.90			++++Structured	<Strd>	[0..n]	

<i>Index</i>	<i>Generic ISO Index</i>	<i>Or</i>	<i>Message Item</i>	<i><XML Tag></i>	<i>Mult.</i>	<i>Type</i>
2.110			+++++CreditorReferenceInformation	<CdtrRefInf>	[0..1]	
2.111			+++++Type	<Tp>	[0..1]	
2.112			+++++CodeOrProprietary	<CdOrPrtry>	[1..1]	
2.113		{Or	+++++Code	<Cd>	[1..1]	Code
2.115			+++++Issuer	<Issr>	[0..1]	Text
2.116			+++++Reference	<Ref>	[0..1]	Text

Annex B Clieop03 equivalent

<i>Index</i>	<i>Generic ISO Index</i>	<i>Or</i>	<i>Message Item</i>	<i><XML Tag></i>	<i>Clieop03 functional equivalent</i>
1.1			<i>MessageIdentification</i>	<i><MsgId></i>	0001-04
1.2			<i>CreationDateTime</i>	<i><CreDtTm></i>	0001-03
1.6			<i>NumberOfTransactions</i>	<i><NbOfTxS></i>	9990-05
1.7			<i>ControlSum</i>	<i><CtrlSum></i>	9990-03
1.8	9.1.0		<i>Name</i>	<i><Nm></i>	0030-05
2.18			<i>RequestedCollectionDate</i>	<i><ReqdColltnDt></i>	0030-04
2.19	9.1.0		<i>Name</i>	<i><Nm></i>	0170-03
2.19	9.1.11		<i>AddressLine</i>	<i><AdrLine></i>	0173-03
2.20	1.1.1	{Or	<i>IBAN</i>	<i><IBAN></i>	0100-06
2.44			<i>InstructedAmount</i>	<i><InstdAmt></i>	0100-04
2.70	6.1.1		<i>BIC</i>	<i><BIC></i>	0010-05
2.72	9.1.0		<i>Name</i>	<i><Nm></i>	0110-03
2.89			<i>Unstructured</i>	<i><Ustrd></i>	0160-03
2.116			<i>Reference</i>	<i><Ref></i>	0150-03

Annex C Rulebook attribute equivalent

Index	Generic ISO Index	<XML Tag>	Rulebook attribute equivalent
2.9		<Cd>	AT-20 The identification code of the Scheme
2.12		<Cd>	AT-20 The identification code of the Scheme
2.14		<SeqTp>	AT-21 Transaction Type
2.15		<CtgyPurp>	AT-59 Category purpose of the Collection
2.18		<ReqdColltnDt>	AT-11 Due Date of the Collection
2.19	9.1.0	<Nm>	AT-03 Name of the Creditor
2.19	9.1.1	<PstlAdr>	AT-05 Address of the Creditor
2.20		<CdtrAcct>	AT-04 Account Number of the Creditor.
2.21	6.1.1	<BIC>	AT-12 BIC of the Creditor Bank
2.23	9.1.0	<Nm>	AT-38 Name of the Creditor Reference Party
2.23	9.1.12	<Id>	AT-39 Identification code of the Creditor Reference Party
2.27	9.1.12	<Id>	AT-02 Identifier of the Creditor
2.31		<EndToEndId>	AT-10 Creditor's reference of the direct debit Collection
2.44		<InstdAmt>	AT-06 Amount of the Collection in Euro
2.48		<MndtId>	AT-01 Unique Mandate Reference
2.49		<DtOfSgntr>	AT-25 Date of Signing of the Mandate
2.51		<AmdmntInfDtls>	AT-24 Reason for Amendment of the Mandate
2.52		<OrgnlMndtId>	AT-19 Unique Mandate Reference as given by the Original Creditor who issued the Mandate
2.53	9.1.0	<Nm>	Original AT-03 Name of the Creditor
2.53	9.1.12	<Id>	AT-18 Identifier of the original Creditor who issued the Mandate
2.62		<ElctrncSgntr>	AT-16 Placeholder for the electronic signature data, if applicable AT-17 Type of Mandate (paper, e-Mandate) AT-60 Reference of the validation made by the Debtor Bank (if present in DS-03)
2.66	9.1.12	<Id>	AT-02 Identifier of the Creditor
2.69	9.1.0	<Nm>	AT-38 Name of the Creditor Reference Party
2.69	9.1.12	<Id>	AT-39 Identification code of the Creditor Reference Party
2.70		<DbtrAgt>	AT-13 BIC of the Debtor BankUsage Rule: Only BIC is allowed.
2.72	9.1.0	<Nm>	AT-14 Name of the Debtor

Index	Generic ISO Index	<XML Tag>	Rulebook attribute equivalent
2.72	9.1.1	<PstlAdr>	AT-09 Address of the Debtor
2.72	9.1.12	<Id>	AT-27 Debtor identification code
2.73		<DbtrAcct>	AT-07 Account Number of the Debtor
2.74	9.1.0	<Nm>	AT-15 Name of the Debtor Reference Party
2.74	9.1.12	<Id>	AT-37 Identification code of the Debtor Reference Party
2.76		<Purp>	AT-58 Purpose of the Collection
2.88		<RmtInf>	AT-22 Remittance information from the Creditor

Annex D Overview ISO codes

The ISO 20022 Payment messages use 'external code lists' which are validated and approved by the Payments SEG.

The listed code values can be used in specific elements of the payments messages as indicated in the documents below. Unlike other ISO 20022 code lists, the code values are not included in the XML message schema with the message element they type. The purpose of externalising these code values is to be able to update the code lists (e.g. add new code values) without impacting the message themselves and, hence, without requiring the development of a new version of the messages that use these code lists.

25 external code lists are published in a spreadsheet which is versioned at three levels: the spreadsheet itself has a publication date, each list within the spreadsheet has a publication date (see 'CodeInventory' sheet) and each individual code value has a date of last update ('status date').

See www.iso20022.org, under “External Code Lists, Data Source Schemes (DSS), Variants and Supplementary Data”, with “External Code Lists spreadsheet” as reference.

http://www.iso20022.org/External_Code_Lists_and_DSS.page

Out of the external code list, the next annex includes the reason codes as these have a restricted set of values within SEPA messages.

Annex E ISO Reason codes used

The reasons for the reversal presented in the Rulebook are mapped to the ISO codes as follows. Other codes may be used when the Creditor has requested the reversal.

ISO Code	ISO Name	SEPA Reason as specifiek in the Rulebook
AM05	Duplication	Duplicate entry
MS02	NotSpecifiedReasonCustomerGenerated	Reason not specified

The reasons for a reject by the Creditor Bank, the Debtor Bank or the CSM as present in the Rulebook are mapped to the ISO codes as follows. Other codes may be used when the Creditor Bank has rejected the message.

ISO Code	ISO Name	SEPA Reason as specifiek in the Rulebook
AC01	IncorrectAccountNumber	Account identifier incorrect (i.e. invalid IBAN)
AC04	ClosedAccountNumber	Account closed
AC06	BlockedAccount	Account blocked Account blocked for Direct Debit by the Debtor
AC13	InvalidDebtorAccountType	Debtor account is a consumer account
AG01	TransactionForbidden	Direct debit forbidden on this account for regulatory reasons
AG02	InvalidBankOperationCode	Operation/transaction code incorrect, invalid file format Usage rule: To be used to indicate an incorrect operation/transaction code
AM04	InsufficientFunds	Insufficient funds
AM05	Duplication	Duplication collection
BE01	InconsistentWithEndCustomer	Debtor's name does not match with the account holder's name
FF01	InvalidFileFormat	Operation/transaction code incorrect, invalid file format Usage Rule: To be used to indicate an invalid file format

MD01	NoMandate	No Mandate
MD02	MissingMandatoryInformationInMandate	Mandate data missing or incorrect
MD07	EndCustomerDeceased	Mandate data missing or incorrect
MS02	NotSpecifiedReasonCustomerGenerated	Refusal by the Debtor
MS03	NotSpecifiedReasonAgentGenerated	Reason not specified
RC01	BankIdentifierIncorrect	Bank identifier incorrect (i.e. invalid BIC)
RR01	MissingDebtorAccountOrIdentification	Regulatory Reason
RR02	MissingDebtorNameOrAddress	Regulatory Reason
RR03	MissingCreditorNameOr Address	Regulatory Reason
RR04	Regulatory Reason	Regulatory Reason
SL01	DueToSpecificServiceOfferedByDebtorAgent	Specific Service offered by the Debtor Bank

Annex F Generic ISO message Items

Index		Message item	XML tag	Mult.	Type
1.1		CashAccount16			
1.1.0		Identification	<Id>	[1..1]	
1.1.1	{Or	+ IBAN	<IBAN>	[1..1]	Identifier
1.1.2	Or}	+ Other	<Othr>	[1..1]	
1.1.3		+ + Identification	<Id>	[1..1]	Text
1.1.4		+ + SchemeName	<SchmeNm>	[0..1]	
1.1.5	{{Or	+ + + Code	<Cd>	[1..1]	Code
1.1.6	Or}}	+ + + Proprietary	<Prtry>	[1..1]	Text
1.1.7		+ + Issuer	<Issr>	[0..1]	Text
1.1.8		Type	<Tp>	[0..1]	
1.1.9	{Or	+ Code	<Cd>	[1..1]	Code
1.1.10	Or}	+ Proprietary	<Prtry>	[1..1]	Text
1.1.11		Currency	<Ccy>	[0..1]	Code
1.1.12		Name	<Nm>	[0..1]	Text
2.1		AmountAndCurrencyExchange3			
2.1.0		InstructedAmount	<InstdAmt>	[0..1]	
2.1.1		Amount	<Amt>	[1..1]	Amount
2.1.2		CurrencyExchange	<CcyXchg>	[0..1]	
2.1.3		SourceCurrency	<SrcCcy>	[1..1]	Code
2.1.4		TargetCurrency	<TrgtCcy>	[0..1]	Code
2.1.5		UnitCurrency	<UnitCcy>	[0..1]	Code
2.1.6		ExchangeRate	<XchgRate>	[1..1]	Rate
2.1.7		ContractIdentification	<CtrctId>	[0..1]	Text
2.1.8		QuotationDate	<QtnDt>	[0..1]	DateTime
2.1.9		TransactionAmount	<TxAmt>	[0..1]	
2.1.10		Amount	<Amt>	[1..1]	Amount
2.1.11		CurrencyExchange	<CcyXchg>	[0..1]	
2.1.12		SourceCurrency	<SrcCcy>	[1..1]	Code
2.1.13		TargetCurrency	<TrgtCcy>	[0..1]	Code
2.1.14		UnitCurrency	<UnitCcy>	[0..1]	Code
2.1.15		ExchangeRate	<XchgRate>	[1..1]	Rate
2.1.16		ContractIdentification	<CtrctId>	[0..1]	Text
2.1.17		QuotationDate	<QtnDt>	[0..1]	DateTime
2.1.18		CounterValueAmount	<CntrValAmt>	[0..1]	
2.1.19		Amount	<Amt>	[1..1]	Amount
2.1.20		CurrencyExchange	<CcyXchg>	[0..1]	
2.1.21		SourceCurrency	<SrcCcy>	[1..1]	Code
2.1.22		TargetCurrency	<TrgtCcy>	[0..1]	Code
2.1.23		UnitCurrency	<UnitCcy>	[0..1]	Code
2.1.24		ExchangeRate	<XchgRate>	[1..1]	Rate

Index		Message item	XML tag	Mult.	Type
2.1.25		ContractIdentification	<CtrctId>	[0..1]	Text
2.1.26		QuotationDate	<QtnDt>	[0..1]	DateTime
2.1.27		AnnouncedPostingAmount	<AnnccdPstngAmt>	[0..1]	
2.1.28		Amount	<Amt>	[1..1]	Amount
2.1.29		CurrencyExchange	<CcyXchg>	[0..1]	
2.1.30		SourceCurrency	<SrcCcy>	[1..1]	Code
2.1.31		TargetCurrency	<TrgtCcy>	[0..1]	Code
2.1.32		UnitCurrency	<UnitCcy>	[0..1]	Code
2.1.33		ExchangeRate	<XchgRate>	[1..1]	Rate
2.1.34		ContractIdentification	<CtrctId>	[0..1]	Text
2.1.35		QuotationDate	<QtnDt>	[0..1]	DateTime
2.1.36		ProprietaryAmount	<PrtryAmt>	[0..n]	
2.1.37		Type	<Tp>	[1..1]	Text
2.1.38		Amount	<Amt>	[1..1]	Amount
2.1.39		CurrencyExchange	<CcyXchg>	[0..1]	
2.1.40		SourceCurrency	<SrcCcy>	[1..1]	Code
2.1.41		TargetCurrency	<TrgtCcy>	[0..1]	Code
2.1.42		UnitCurrency	<UnitCcy>	[0..1]	Code
2.1.43		ExchangeRate	<XchgRate>	[1..1]	Rate
2.1.44		ContractIdentification	<CtrctId>	[0..1]	Text
2.1.45		QuotationDate	<QtnDt>	[0..1]	DateTime
3.1		CurrencyAndAmountRange2			
3.1.0		Amount	<Amt>	[1..1]	
3.1.1	{Or	+ FromAmount	<FrAmt>	[1..1]	
3.1.2		+ + BoundaryAmount	<BdryAmt>	[1..1]	Amount
3.1.3		+ + Included	<Incl>	[1..1]	Indicator
3.1.4	Or	+ ToAmount	<ToAmt>	[1..1]	
3.1.5		+ + BoundaryAmount	<BdryAmt>	[1..1]	Amount
3.1.6		+ + Included	<Incl>	[1..1]	Indicator
3.1.7	Or	FromToAmount	<FrToAmt>	[1..1]	
3.1.8		+ FromAmount	<FrAmt>	[1..1]	
3.1.9		+ + BoundaryAmount	<BdryAmt>	[1..1]	Amount
3.1.10		+ + Included	<Incl>	[1..1]	Indicator
3.1.11		+ ToAmount	<ToAmt>	[1..1]	
3.1.12		+ + BoundaryAmount	<BdryAmt>	[1..1]	Amount
3.1.13		+ + Included	<Incl>	[1..1]	Indicator
3.1.14	Or	+ EqualAmount	<EQAmt>	[1..1]	Amount
3.1.15	Or}	+ NotEqualAmount	<NEQAmt>	[1..1]	Amount
3.1.16		CreditDebitIndicator	<CdtDbtInd>	[0..1]	Code
3.1.17		Currency	<Ccy>	[1..1]	Code
4.1		DateAndDateTimeChoice			
4.1.0	{Or	Date	<Dt>	[1..1]	Date
4.1.1	Or}	DateTime	<DtTm>	[1..1]	DateTime

Index		Message item	XML tag	Mult.	Type
5.1		<i>DateTimePeriodDetails</i>			
5.1.0		<i>FromDateTime</i>	<FrDtTm>	[1..1]	DateTime
5.1.1		<i>ToDateTime</i>	<ToDtTm>	[1..1]	DateTime
6.1		<i>BranchAndFinancialInstitutionIdentification4</i>			
6.1.0		<i>FinancialInstitutionIdentification</i>	<FinInstnId>	[1..1]	
6.1.1		+ BIC	<BIC>	[0..1]	Identifier
6.1.2		+ <i>ClearingSystemMemberIdentification</i>	<ClrSysMmbld>	[0..1]	
6.1.3		+ + <i>ClearingSystemIdentification</i>	<ClrSysId>	[0..1]	
6.1.4		+ + + Code	<Cd>	[1..1]	Code
6.1.5		+ + + Proprietary	<Prtry>	[1..1]	Text
6.1.6		+ + <i>MemberIdentification</i>	<Mmbld>	[1..1]	Text
6.1.7	{Or	+ Name	<Nm>	[0..1]	Text
6.1.8	{Or	+ <i>PostalAddress</i>	<PstlAdr>	[0..1]	
6.1.9	Or}	+ + <i>AddressType</i>	<AdrTp>	[0..1]	Code
6.1.10	Or}	+ + <i>Department</i>	<Dept>	[0..1]	Text
6.1.11		+ + <i>SubDepartment</i>	<SubDept>	[0..1]	Text
6.1.12		+ + <i>StreetName</i>	<StrtNm>	[0..1]	Text
6.1.13		+ + <i>BuildingNumber</i>	<BldgNb>	[0..1]	Text
6.1.14		+ + <i>PostCode</i>	<PstCd>	[0..1]	Text
6.1.15		+ + <i>TownName</i>	<TwnNm>	[0..1]	Text
6.1.16		+ + <i>CountrySubDivision</i>	<CtrySubDvsn>	[0..1]	Text
6.1.17		+ + <i>Country</i>	<Ctry>	[0..1]	Code
6.1.18		+ + <i>AddressLine</i>	<AdrLine>	[0..7]	Text
6.1.19		+ <i>Other</i>	<Othr>	[0..1]	
6.1.20		+ + <i>Identification</i>	<Id>	[1..1]	Text
6.1.21		+ + <i>SchemeName</i>	<SchmeNm>	[0..1]	
6.1.22		+ + + Code	<Cd>	[1..1]	Code
6.1.23		+ + + Proprietary	<Prtry>	[1..1]	Text
6.1.24		+ + <i>Issuer</i>	<Issr>	[0..1]	Text
6.1.25		<i>BranchIdentification</i>	<BrnchId>	[0..1]	
6.1.26		+ <i>Identification</i>	<Id>	[0..1]	Text
6.1.27		+ Name	<Nm>	[0..1]	Text
6.1.28		+ + <i>PostalAddress</i>	<PstlAdr>	[0..1]	
6.1.29		+ + <i>AddressType</i>	<AdrTp>	[0..1]	Code
6.1.30		+ + <i>Department</i>	<Dept>	[0..1]	Text
6.1.31	{Or	+ + <i>SubDepartment</i>	<SubDept>	[0..1]	Text
6.1.32	Or}	+ + <i>StreetName</i>	<StrtNm>	[0..1]	Text
6.1.33		+ + <i>BuildingNumber</i>	<BldgNb>	[0..1]	Text
6.1.34		+ + <i>PostCode</i>	<PstCd>	[0..1]	Text
6.1.35		+ + <i>TownName</i>	<TwnNm>	[0..1]	Text
6.1.36		+ + <i>CountrySubDivision</i>	<CtrySubDvsn>	[0..1]	Text
6.1.37		+ + <i>Country</i>	<Ctry>	[0..1]	Code
6.1.38		+ + <i>AddressLine</i>	<AdrLine>	[0..7]	Text

Index		Message item	XML tag	Mult.	Type
7.1		GenericIdentification3			
7.1.0		Identification	<Id>	[1..1]	Text
7.1.1		Issuer	<Issr>	[0..1]	Text
8.1		Pagination			
8.1.0		PageNumber	<PgNb>	[1..1]	Text
8.1.1		LastPageIndicator	<LastPgInd>	[1..1]	Indicator
9.1		PartyIdentification32			
9.1.0		Name	<Nm>	[0..1]	Text
9.1.1		PostalAddress	<PstAdr>	[0..1]	
9.1.2		+ AddressType	<AdrTp>	[0..1]	Code
9.1.3		+ Department	<Dept>	[0..1]	Text
9.1.4		+ SubDepartment	<SubDept>	[0..1]	Text
9.1.5		+ StreetName	<StrtNm>	[0..1]	Text
9.1.6		+ BuildingNumber	<BldgNb>	[0..1]	Text
9.1.7		+ PostCode	<PstCd>	[0..1]	Text
9.1.8		+ TownName	<TwnNm>	[0..1]	Text
9.1.9		+ CountrySubDivision	<CtrySubDvsn>	[0..1]	Text
9.1.10		+ Country	<Ctry>	[0..1]	Code
9.1.11		+ AddressLine	<AdrLine>	[0..7]	Text
9.1.12		Identification	<Id>	[0..1]	
9.1.13		+ OrganisationIdentification	<OrgId>	[1..1]	
9.1.14		+ + BICOrBEI	<BICOrBEI>	[0..1]	Identifier
9.1.15		+ + Other	<Othr>	[0..n]	
9.1.16		+ + + Identification	<Id>	[1..1]	Text
9.1.17		+ + + SchemeName	<SchmeNm>	[0..1]	
9.1.18		+ + + + Code	<Cd>	[1..1]	Code
9.1.19		+ + + + Proprietary	<Prtry>	[1..1]	Text
9.1.20		+ + + Issuer	<Issr>	[0..1]	Text
9.1.21		+ PrivateIdentification	<PrvtId>	[1..1]	
9.1.22		+ + DateAndPlaceOfBirth	<DtAndPlcOfBirth>	[0..1]	
9.1.23	{Or	+ + + BirthDate	<BirthDt>	[1..1]	Date
9.1.24	{Or	+ + + ProvinceOfBirth	<PrvcOfBirth>	[0..1]	Text
9.1.25		+ + + CityOfBirth	<CityOfBirth>	[1..1]	Text
9.1.26		+ + + CountryOfBirth	<CtryOfBirth>	[1..1]	Code
9.1.27		+ + Other	<Othr>	[0..n]	
9.1.28		+ + + Identification	<Id>	[1..1]	Text
9.1.29		+ + + SchemeName	<SchmeNm>	[0..1]	
9.1.30		+ + + + Code	<Cd>	[1..1]	Code
9.1.31		+ + + + Proprietary	<Prtry>	[1..1]	Text
9.1.32		+ + + Issuer	<Issr>	[0..1]	Text
9.1.33		CountryOfResidence	<CtryOfRes>	[0..1]	Code
9.1.34	{{Or	ContactDetails	<CtctDtls>	[0..1]	
9.1.35	{Or	+ NamePrefix	<NmPrfx>	[0..1]	Code

Index		Message item	XML tag	Mult.	Type
9.1.36	Or}}	+ Name	<Nm>	[0..1]	Text
9.1.37	Or}	+ PhoneNumber	<PhneNb>	[0..1]	Text
9.1.38		+ MobileNumber	<MobNb>	[0..1]	Text
9.1.39		+ FaxNumber	<FaxNb>	[0..1]	Text
9.1.40	Or}	+ EmailAddress	<EmailAdr>	[0..1]	Text
9.1.41	Or}	+ Other	<Othr>	[0..1]	Text
10.1		PostalAddress6			
10.1.0		AddressType	<AdrTp>	[0..1]	Code
10.1.1		Department	<Dept>	[0..1]	Text
10.1.2		SubDepartment	<SubDept>	[0..1]	Text
10.1.3		StreetName	<StrtNm>	[0..1]	Text
10.1.4		BuildingNumber	<BldgNb>	[0..1]	Text
10.1.5		PostCode	<PstCd>	[0..1]	Text
10.1.6		TownName	<TwnNm>	[0..1]	Text
10.1.7		CountrySubDivision	<CtrySubDvsn>	[0..1]	Text
10.1.8		Country	<Ctry>	[0..1]	Code
10.1.9		AddressLine	<AdrLine>	[0..7]	Text
11.1		RegulatoryReporting3			
11.1.0		DebitCreditReportingIndicator	<DbtCdtRptgInd>	[0..1]	Code
11.1.1		Authority	<Authrty>	[0..1]	
11.1.2		+ Name	<Nm>	[0..1]	Text
11.1.3		+ Country	<Ctry>	[0..1]	Code
11.1.4		Details	<Dtls>	[0..n]	
11.1.5		+ Type	<Tp>	[0..1]	Text
11.1.6		+ Date	<Dt>	[0..1]	Date
11.1.7		+ Country	<Ctry>	[0..1]	Code
11.1.8		+ Code	<Cd>	[0..1]	Text
11.1.9		+ Amount	<Amt>	[0..1]	Amount
11.1.10		+ Information	<Inf>	[0..n]	Text
12.1		FinancialInstrumentQuantityChoice			
12.1.0	{Or	Unit	<Unit>	[1..1]	Quantity
12.1.1	Or	FaceAmount	<FaceAmt>	[1..1]	Amount
12.1.2	Or}	AmortisedValue	<AmtsdVal>	[1..1]	Amount
13.1		TaxInformation3			
13.1.0		Creditor	<Cdtr>	[0..1]	
13.1.1		+ TaxIdentification	<TaxId>	[0..1]	Text
13.1.2		+ RegistrationIdentification	<RegnId>	[0..1]	Text
13.1.3		+ TaxType	<TaxTp>	[0..1]	Text
13.1.4		Debtor	<Dbtr>	[0..1]	
13.1.5		+ TaxIdentification	<TaxId>	[0..1]	Text
13.1.6		+ RegistrationIdentification	<RegnId>	[0..1]	Text
13.1.7		+ TaxType	<TaxTp>	[0..1]	Text
13.1.8		+ Authorisation	<Authstn>	[0..1]	

Index	Message item	XML tag	Mult.	Type
13.1.9	<i>++ Title</i>	<Titl>	[0..1]	Text
13.1.10	<i>++ Name</i>	<Nm>	[0..1]	Text
13.1.11	<i>AdministrationZone</i>	<AdmstnZn>	[0..1]	Text
13.1.12	<i>ReferenceNumber</i>	<RefNb>	[0..1]	Text
13.1.13	<i>Method</i>	<Mtd>	[0..1]	Text
13.1.14	<i>TotalTaxableBaseAmount</i>	<TtlTaxblBaseAmt>	[0..1]	Amount
13.1.15	<i>TotalTaxAmount</i>	<TtlTaxAmt>	[0..1]	Amount
13.1.16	<i>Date</i>	<Dt>	[0..1]	Date
13.1.17	<i>SequenceNumber</i>	<SeqNb>	[0..1]	Quantity
13.1.18	<i>Record</i>	<Rcrd>	[0..n]	
13.1.19	<i>+ Type</i>	<Tp>	[0..1]	Text
13.1.20	<i>+ Category</i>	<Ctgy>	[0..1]	Text
13.1.21	<i>+ CategoryDetails</i>	<CtgyDtls>	[0..1]	Text
13.1.22	<i>+ DebtorStatus</i>	<DbtrSts>	[0..1]	Text
13.1.23	<i>+ CertificateIdentification</i>	<CertId>	[0..1]	Text
13.1.24	<i>+ FormsCode</i>	<FrmsCd>	[0..1]	Text
13.1.25	<i>+ Period</i>	<Prd>	[0..1]	
13.1.26	<i>++ Year</i>	<Yr>	[0..1]	Date
13.1.27	<i>++ Type</i>	<Tp>	[0..1]	Code
13.1.28	<i>++ FromToDate</i>	<FrToDt>	[0..1]	
13.1.29	<i>+++ FromDate</i>	<FrDt>	[1..1]	Date
13.1.30	<i>+++ ToDate</i>	<ToDt>	[1..1]	Date
13.1.31	<i>+ TaxAmount</i>	<TaxAmt>	[0..1]	
13.1.32	<i>++ Rate</i>	<Rate>	[0..1]	Rate
13.1.33	<i>++ TaxableBaseAmount</i>	<TaxblBaseAmt>	[0..1]	Amount
13.1.34	<i>++ TotalAmount</i>	<TtlAmt>	[0..1]	Amount
13.1.35	<i>+++ Details</i>	<Dtls>	[0..n]	
13.1.36	<i>+++ Period</i>	<Prd>	[0..1]	
13.1.37	<i>++++ Year</i>	<Yr>	[0..1]	Date
13.1.38	<i>++++ Type</i>	<Tp>	[0..1]	Code
13.1.39	<i>+++ FromToDate</i>	<FrToDt>	[0..1]	
13.1.40	<i>++++ FromDate</i>	<FrDt>	[1..1]	Date
13.1.41	<i>++++ ToDate</i>	<ToDt>	[1..1]	Date
13.1.42	<i>++ Amount</i>	<Amt>	[1..1]	Amount
13.1.43	<i>+ AdditionalInformation</i>	<AddtlInf>	[0..1]	Text

Annex G Example message

```
<?xml version="1.0" encoding="UTF-8"?>
<Document xmlns="urn:iso:std:iso:2002:tech:xsd:pain.008.001.02"
xmlns:xsi="http://www.w3.org/2001/XMLSchema-instance">
  <CstmrDrctDbtInitn>
    <GrpHdr>
      <MsgId>message-id-SDD-001</MsgId>
      <CreDtTm>2010-08-25T14:25:00</CreDtTm>
      <NbOfTxs>3</NbOfTxs>
      <CtrlSum>30.6</CtrlSum>
      <InitgPty>
        <Nm>Bedrijfsnaam</Nm>
      </InitgPty>
    </GrpHdr>
    <PmtInf>
      <PmtInflId>Minimaal gevuld</PmtInflId>
      <PmtMtd>DD</PmtMtd>
      <BtchBookg>false</BtchBookg>
      <NbOfTxs>1</NbOfTxs>
      <CtrlSum>10.1</CtrlSum>
      <PmtTpInf>
        <SvcLvl>
          <Cd>SEPA</Cd>
        </SvcLvl>
        <LclInstrm>
          <Cd>CORE</Cd>
        </LclInstrm>
        <SeqTp>FRST</SeqTp>
      </PmtTpInf>
      <ReqdColltnDt>2010-09-12</ReqdColltnDt>
      <Cdtr>
        <Nm>Bedrijfsnaam incassant</Nm>
      </Cdtr>
      <CdtrAcct>
        <Id>
          <IBAN>NL90ABNA0111111111</IBAN>
        </Id>
      </CdtrAcct>
      <CdtrAgt>
        <FinInstnId>
          <BIC>ABNANL2A</BIC>
        </FinInstnId>
      </CdtrAgt>
      <ChrgBr>SLEV</ChrgBr>
      <CdtrSchmeld>
        <Nm>bedrijfsnaam incassant (op mandaat)</Nm>
        <Id>
```

```

        <PrvtId>
            <Othr>
                <Id>NL64ZZZ321096320000</Id>
                <SchmeNm>
                    <Prtry>SEPA</Prtry>
                </SchmeNm>
            </Othr>
        </PrvtId>
    </Id>
</CdtrSchmeld>
<DrctDbtTxInf>
    <PmtId>
        <EndToEndId>non ref</EndToEndId>
    </PmtId>
    <InstdAmt Ccy="EUR">10.1</InstdAmt>
    <DrctDbtTx>
        <MndtRltdInf>
            <MndtId>mandaat identificatie nummer</MndtId>
            <DtOfSgntr>2008-07-13</DtOfSgntr>
        </MndtRltdInf>
    </DrctDbtTx>
    <DbtrAgt>
        <FinInstnId>
            <BIC>RABONL2U</BIC>
        </FinInstnId>
    </DbtrAgt>
    <Dbtr>
        <Nm>Debtor naam</Nm>
    </Dbtr>
    <DbtrAcct>
        <Id>
            <IBAN>NL44RABO0123456789</IBAN>
        </Id>
    </DbtrAcct>
    <RmtInf>
        <Ustrd>Omschrijving</Ustrd>
    </RmtInf>
</DrctDbtTxInf>
</PmtInf>
<PmtInf>
    <PmtInfId>Maximaal gevuld</PmtInfId>
    <PmtMtd>DD</PmtMtd>
    <BtchBookg>>false</BtchBookg>
    <NbOfTx>2</NbOfTx>
    <CtrlSum>20.5</CtrlSum>
    <PmtTplInf>
        <SvcLvl>
            <Cd>SEPA</Cd>
        </SvcLvl>

```

```

    <LclInstrm>
      <Cd>CORE</Cd>
    </LclInstrm>
    <SeqTp>RCUR</SeqTp>
    <CtgyPurp>
      <Cd>DCRD</Cd>
    </CtgyPurp>
  </PmtTpInf>
  <ReqdColltnDt>2010-09-12</ReqdColltnDt>
  <Cdtr>
    <Nm>Bedrijfsnaam incassant</Nm>
  </Cdtr>
  <CdtrAcct>
    <Id>
      <IBAN>NL90ABNA0111111111</IBAN>
    </Id>
  </CdtrAcct>
  <CdtrAgt>
    <FinInstnId>
      <BIC>ABNANL2A</BIC>
    </FinInstnId>
  </CdtrAgt>
  <UltmtCdtr>
    <Id>
      <PrvtId>
        <Othr>
          <Id>12345678</Id>
          <SchmeNm>
            <Prtry>KVK nummer</Prtry>
          </SchmeNm>
          <Issr>KVK</Issr>
        </Othr>
      </PrvtId>
    </Id>
  </UltmtCdtr>
  <ChrgBr>SLEV</ChrgBr>
  <CdtrSchmeld>
    <Nm>bedrijfsnaam incassant (op mandaat)</Nm>
    <Id>
      <PrvtId>
        <Othr>
          <Id>NL64ZZZ321096320000</Id>
          <SchmeNm>
            <Prtry>SEPA</Prtry>
          </SchmeNm>
        </Othr>
      </PrvtId>
    </Id>
  </CdtrSchmeld>

```

```

<DrctDbtTxInf>
  <PmtId>
    <EndToEndId>1234567</EndToEndId>
  </PmtId>
  <InstdAmt Ccy="EUR">10.2</InstdAmt>
  <DrctDbtTx>
    <MndtRltdInf>
      <MndtId>mandaat ID met voorbeeld ID change</MndtId>
      <DtOfSgntr>2008-07-13</DtOfSgntr>
      <AmdmntInd>true</AmdmntInd>
      <AmdmntInfDtls>
        <OrgnlMndtId>vorig mandaat nummer</OrgnlMndtId>
      </AmdmntInfDtls>
    </MndtRltdInf>
  </DrctDbtTx>
  <DbtrAgt>
    <FinInstnId>
      <BIC>RABONL2U</BIC>
    </FinInstnId>
  </DbtrAgt>
  <Dbtr>
    <Nm>Debtor naam</Nm>
    <PstlAdr>
      <AdrLine>straatnaam debtor 99</AdrLine>
      <AdrLine>9999 XX stadsnaam</AdrLine>
    </PstlAdr>
  </Dbtr>
  <DbtrAcct>
    <Id>
      <IBAN>NL44RABO0123456789</IBAN>
    </Id>
  </DbtrAcct>
  <UltmtDbtr>
    <Id>
      <PrvtId>
        <DtAndPlcOfBirth>
          <BirthDt>1970-01-01</BirthDt>
          <CityOfBirth>STADSNAAM</CityOfBirth>
          <CtryOfBirth>NL</CtryOfBirth>
        </DtAndPlcOfBirth>
      </PrvtId>
    </Id>
  </UltmtDbtr>
  <Purp>
    <Cd>AREN</Cd>
  </Purp>
  <RmtInf>
    <Ustrd>Omschrijving</Ustrd>
  </RmtInf>

```

```

</DrctDbtTxInf>
  <DrctDbtTxInf>
    <PmtId>
      <EndToEndId>met NL betalingskenmerk</EndToEndId>
    </PmtId>
    <InstdAmt Ccy="EUR">10.3</InstdAmt>
    <DrctDbtTx>
      <MndtRltdInf>
        <MndtId>mandaat ID 2 met naamwijziging</MndtId>
        <DtOfSgntr>2008-07-13</DtOfSgntr>
        <AmdmntInd>true</AmdmntInd>
        <AmdmntInfDtls>
          <OrgnlCdtrSchmeld>
            <Nm>oude bedrijfsnaam</Nm>
          </OrgnlCdtrSchmeld>
        </AmdmntInfDtls>
      </MndtRltdInf>
    </DrctDbtTx>
    <DbtrAgt>
      <FinInstnId>
        <BIC>INGBNL2A</BIC>
      </FinInstnId>
    </DbtrAgt>
    <Dbtr>
      <Nm>Debtor naam</Nm>
      <PstlAdr>
        <AdrLine>straatnaam debtor 99</AdrLine>
        <AdrLine>9999 XX stadsnaam</AdrLine>
      </PstlAdr>
    </Dbtr>
    <DbtrAcct>
      <Id>
        <IBAN>NL51INGB0000123456</IBAN>
      </Id>
    </DbtrAcct>
    <UltmtDbtr>
      <Id>
        <OrgId>
          <BICOrBEI>HBUANL2R</BICOrBEI>
        </OrgId>
      </Id>
    </UltmtDbtr>
    <RmtInf>
      <Strd>
        <CdtrRefInf>
          <Tp>
            <CdOrPrtry>
              <Cd>SCOR</Cd>
            </CdOrPrtry>
          </Tp>
        </CdtrRefInf>
      </Strd>
    </RmtInf>
  </DrctDbtTxInf>

```

```

</Document>
  </CstmrDrctDbtInitn>
    </PmtInf>
      </DrctDbtTxInf>
        </RmtInf>
          </Strd>
            </CdtrRefInf>
              <Ref>123456788</Ref>
            </Tp>
          <Issr>CUR</Issr>

```

For an XML-pain.008.001.02 message example go to:

<http://www.betaalvereniging.nl/wp-uploads/2013/01/BvN-pain.008.001.02-example-message.xml>

Annex H Overview of applicable usage rules

Index	Or	Message Item	Applicable Usage Rules		
			ISO	EPC	NL
0.0		+Message root			
1.0		+GroupHeader			
1.1		++MessageIdentification	X		
1.2		++CreationDateTime			
1.6		++NumberOfTransactions			
1.7		++ControlSum			X
1.8		++InitiatingParty	X	X	
1.8		+++Name			
1.8		+++Identification			
1.8	{Or	++++OrganisationIdentification			
1.8		+++++BICOrBEI			
1.8		+++++Other			
1.8		++++++Identification			
1.8		++++++SchemeName			
1.8	{{Or	+++++++Code			
1.8	Or}}	+++++++Proprietary			
1.8		+++++++Issuer			
1.8	Or}	++++PrivateIdentification			
1.8		+++++DateAndPlaceOfBirth			
1.8		+++++BirthDate			
1.8		+++++ProvinceOfBirth			
1.8		+++++CityOfBirth			
1.8		+++++CountryOfBirth			
1.8		+++++Other			
1.8		+++++Identification			
1.8		+++++SchemeName			
1.8	{{Or	+++++++Code			
1.8	Or}}	+++++++Proprietary			
1.8		+++++++Issuer			
2.0		++PaymentInformation			
2.1		++PaymentInformationIdentification			
2.2		++PaymentMethod			
2.3		++BatchBooking	X	X	
2.4		++NumberOfTransactions			
2.5		++ControlSum			X
2.6		++PaymentTypeInformation	X	X	
2.8		+++ServiceLevel		X	
2.9	{Or	++++Code		X	
2.11		+++LocalInstrument	X	X	

Index	Or	Message Item	Applicable Usage Rules		
			ISO	EPC	NL
2.12	{Or	++++Code		X	
2.14		+++SequenceType		X	X
2.15		+++CategoryPurpose	X	X	
2.16	{Or	++++Code			
2.17	Or}	++++Proprietary			
2.18		++RequestedCollectionDate			
2.19		+++Creditor		X	
2.19		++++Name		X	
2.19		++++PostalAddress		X	
2.19		+++++Country			
2.19		+++++AddressLine			
2.20		+++CreditorAccount		X	
2.20		+++Identification		X	
2.20	{Or	++++IBAN		X	
2.21		+++CreditorAgent		X	
2.21		++++FinancialInstitutionIdentification		X	
2.21		+++++BIC		X	
2.23		+++UltimateCreditor	X	X	
2.23		++++Name		X	
2.23		++++Identification		X	
2.23	{Or	+++++OrganisationIdentification		X	
2.23		+++++BICorBEI		X	
2.23		+++++Other		X	
2.23		+++++Identification			
2.23		+++++SchemeName			
2.23	{{Or	+++++Code			
2.23	Or}}	+++++Proprietary			
2.23		+++++Issuer			
2.23	Or}	+++++PrivateIdentification		X	
2.23		+++++DateAndPlaceOfBirth		X	
2.23		+++++BirthDate			
2.23		+++++ProvinceOfBirth			
2.23		+++++CityOfBirth			
2.23		+++++CountryOfBirth			
2.23		+++++Other		X	
2.23		+++++Identification			
2.23		+++++SchemeName			
2.23	{{Or	+++++Code			
2.23	Or}}	+++++Proprietary			
2.23		+++++Issuer			
2.24		++ChargeBearer	X	X	
2.27		++CreditorSchemeIdentification	X	X	X

Index	Or	Message Item	Applicable Usage Rules		
			ISO	EPC	NL
2.27		++++Identification		X	
2.27	Or}	+++++Privateldentification		X	
2.27		++++++Other		X	
2.27		+++++++Identification			
2.27		+++++++SchemeName		X	
2.27	{{Or	+++++++Code			
2.27	Or}}	+++++++Proprietary		X	
2.27		+++++++Issuer			
2.28		++DirectDebitTransactionInformation			
2.29		+++PaymentIdentification			
2.30		++++InstructionIdentification	X		
2.31		++++EndToEndIdentification	X		
2.44		+++InstructedAmount	X	X	
2.45		+++ChargeBearer		X	
2.46		+++DirectDebitTransaction		X	
2.47		++++MandateRelatedInformation	X	X	
2.48		+++++Mandateldentification		X	
2.49		+++++DateOfSignature		X	
2.50		+++++AmendmentIndicator			
2.51		+++++AmendmentInformationDetails		X	
2.52		+++++OriginalMandateldentification		X	
2.53		+++++OriginalCreditorSchemeIdentification		X	
2.53		+++++Name			
2.53		+++++Identification			
2.53	Or}	+++++++Privateldentification		X	
2.53		+++++++Other		X	
2.53		+++++++Identification			
2.53		+++++++SchemeName		X	
2.53	{{Or	+++++++Code			
2.53	Or}}	+++++++Proprietary		X	
2.53		+++++++Issuer			
2.57		+++++OriginalDebtorAccount		X	
2.57		+++++Identification		X	
2.57	{Or	+++++IBAN		X	
2.58		+++++OriginalDebtorAgent		X	
2.58		+++++FinancialInstitutionIdentification		X	
2.58		+++++Other		X	
2.58		+++++Identification			
2.58	Or}	+++++++Proprietary		X	
2.62		+++++ElectronicSignature		X	
2.66		+++++CreditorSchemeIdentification		X	

Index	Or	Message Item	Applicable Usage Rules		
			ISO	EPC	NL
2.66		+++++Identification		X	
2.66	Or}	+++++++PrivateIdentification		X	
2.66		+++++++Other		X	
2.66		+++++++Identification			
2.66		+++++++SchemeName		X	
2.66	{{Or	+++++++Code			
2.69		++++UltimateCreditor		X	
2.69		++++Name		X	
2.69		++++Identification			
2.69	{Or	++++OrganisationIdentification		X	
2.69		++++BICOrBEI		X	
2.69		++++Other		X	
2.69		++++Identification			
2.69		++++SchemeName			
2.69	{{Or	++++Code			
2.69	Or}}	++++Proprietary			
2.69		++++Issuer			
2.69	Or}	++++PrivateIdentification		X	
2.69		++++DateAndPlaceOfBirth		X	
2.69		++++BirthDate			
2.69		++++ProvinceOfBirth			
2.69		++++CityOfBirth			
2.69		++++CountryOfBirth			
2.69		++++Other		X	
2.69		++++Identification			
2.69		++++SchemeName			
2.69	{{Or	++++Code			
2.69	Or}}	++++Proprietary			
2.69		++++Issuer			
2.70		++++DebtorAgent		X	
2.70		++++FinancialInstitutionIdentification		X	
2.70		++++BIC		X	
2.72		++++Debtor		X	
2.72		++++Name		X	
2.72		++++PostalAddress			
2.72		++++Country			
2.72		++++AddressLine		X	
2.72		++++Identification			
2.72	{Or	++++OrganisationIdentification		X	
2.72		++++BICOrBEI		X	
2.72		++++Other		X	
2.72		++++Identification			

Index	Or	Message Item	Applicable Usage Rules		
			ISO	EPC	NL
2.72		+++++++SchemeName			
2.72	{{Or	+++++++Code			
2.72	Or}}	+++++++Proprietary			
2.72		+++++++Issuer			
2.72	Or}	+++++PrivateIdentification		X	
2.72		+++++DateAndPlaceOfBirth		X	
2.72		+++++++BirthDate			
2.72		+++++++ProvinceOfBirth			
2.72		+++++++CityOfBirth			
2.72		+++++++CountryOfBirth			
2.72		+++++Other		X	
2.72		+++++++Identification			
2.72		+++++++SchemeName			
2.72	{{Or	+++++++Code			
2.72	Or}}	+++++++Proprietary			
2.72		+++++++Issuer			
2.73		++++DebtorAccount		X	
2.73		++++Identification		X	
2.73	{Or	+++++IBAN		X	
2.73		+++++Currency			
2.74		++++UltimateDebtor		X	
2.74		++++Name		X	
2.74		++++Identification			
2.74	{Or	+++++OrganisationIdentification		X	
2.74		+++++BICorBEI		X	
2.74		+++++Other		X	
2.74		+++++++Identification			
2.74		+++++++SchemeName			
2.74	{{Or	+++++++Code			
2.74	Or}}	+++++++Proprietary			
2.74		+++++++Issuer			
2.74	Or}	+++++PrivateIdentification		X	
2.74		+++++DateAndPlaceOfBirth		X	
2.74		+++++++BirthDate			
2.74		+++++++ProvinceOfBirth			
2.74		+++++++CityOfBirth			
2.74		+++++++CountryOfBirth			
2.74		+++++Other		X	
2.74		+++++++Identification			
2.74		+++++++SchemeName			
2.74	{{Or	+++++++Code			
2.74	Or}}	+++++++Proprietary			

<i>Index</i>	<i>Or</i>	<i>Message Item</i>	<i>Applicable Usage Rules</i>		
			<i>ISO</i>	<i>EPC</i>	<i>NL</i>
2.74		+++++++Issuer			
2.76		++++Purpose	X		
2.77	{Or	++++Code			
2.88		++++RemittanceInformation		X	X
2.89		++++Unstructured		X	
2.90		++++Structured		X	X
2.110		+++++CreditorReferenceInformation		X	
2.111		+++++Type			
2.112		+++++CodeOrProprietary			
2.113	{Or	+++++Code		X	
2.115		+++++Issuer			X
2.116		+++++Reference	X	X	X